

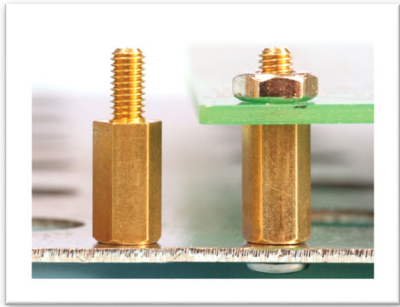

# 塑料铜柱

FEMALE-FEMALE STANDOFF



# 圆体隔离柱

ROUND SPACER

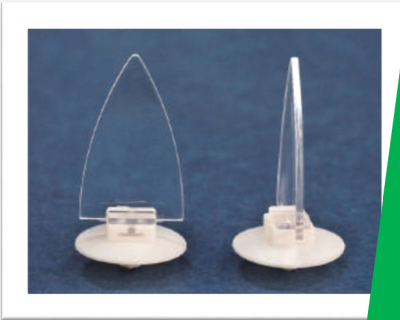

# 导光板隔离柱

PILLAR SUPPORT



# 导电隔离柱

SPACER SUPPORT

电子电脑塑胶五金零件

PLASTIC HARDWARE & ELECTRONIC COMPONENTS

2023 EDITON

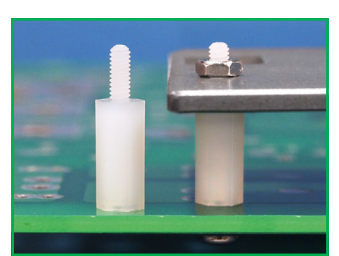
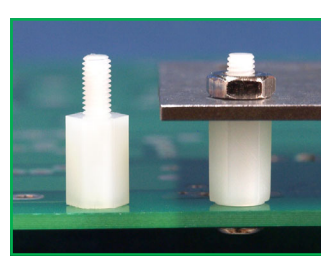
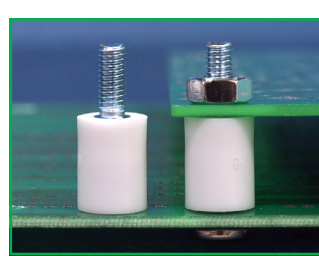
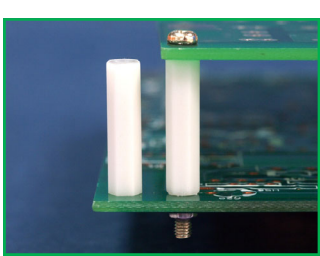
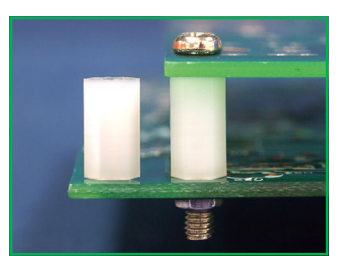
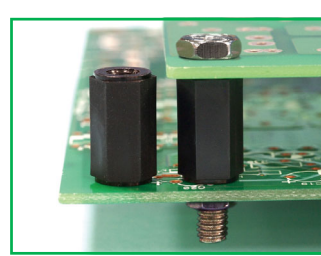
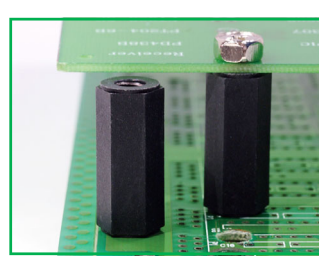
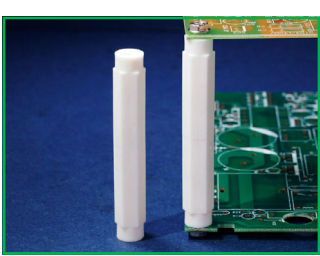
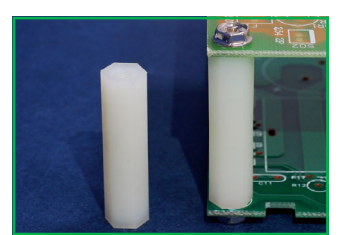
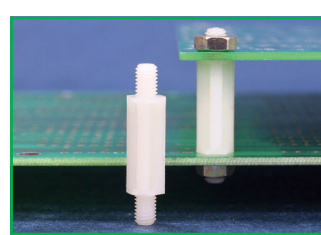
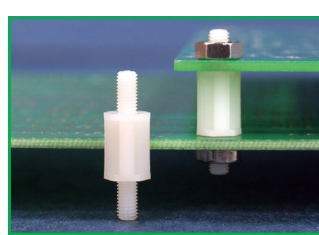
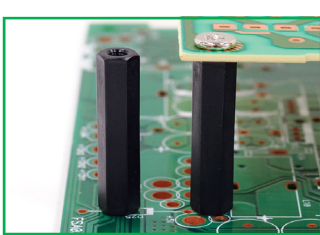
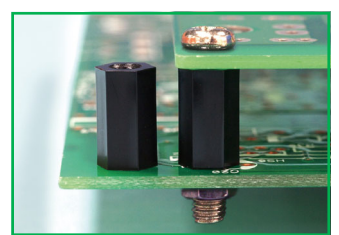
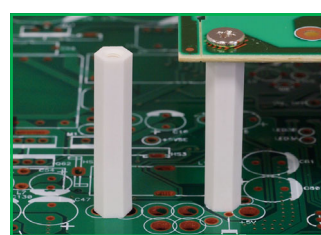
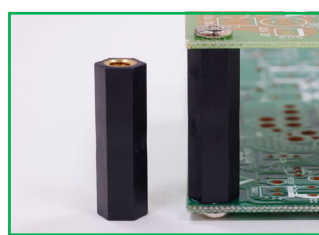
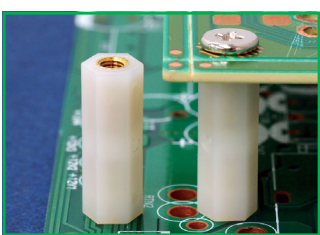
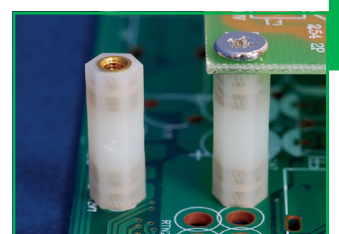
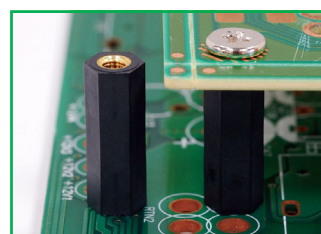
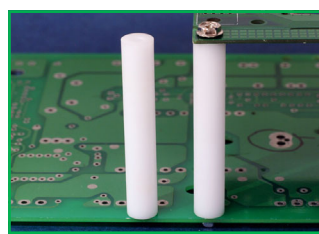
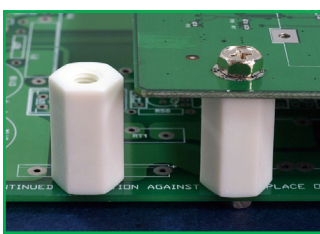
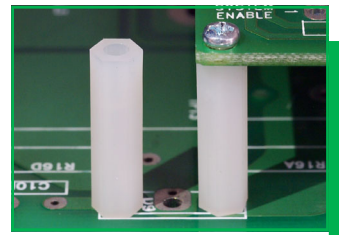
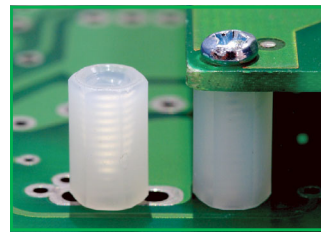
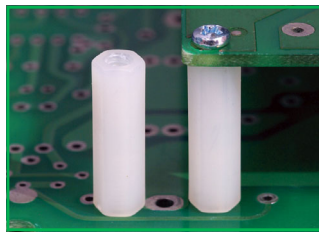
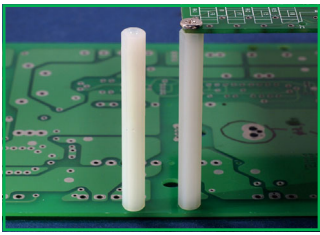
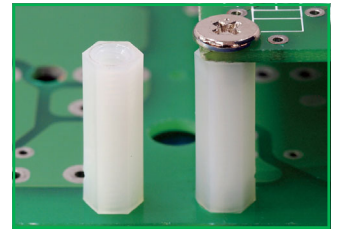
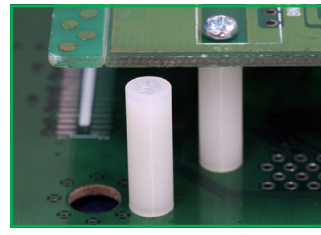
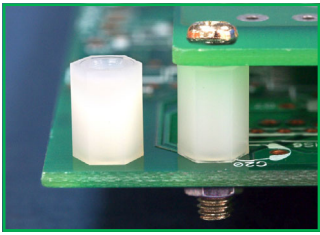

PC板塑料铜柱

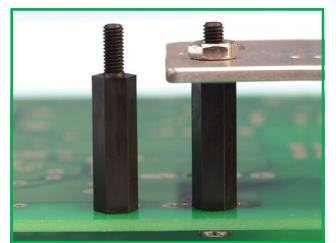
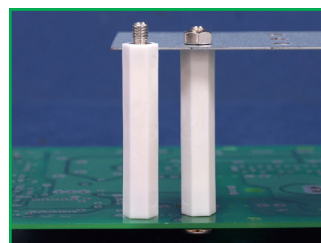
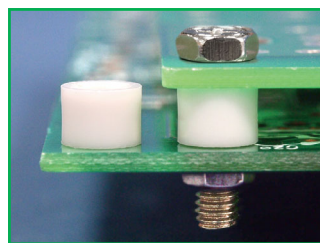
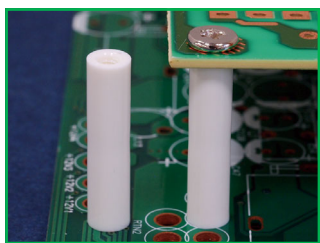
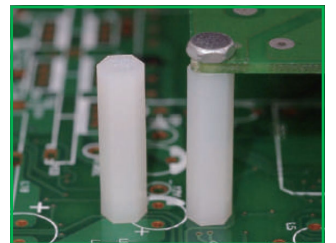
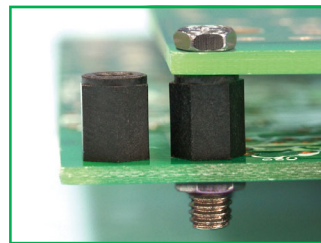
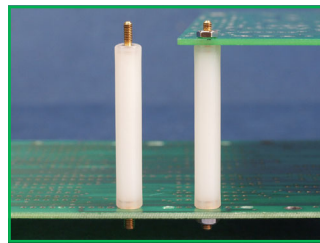
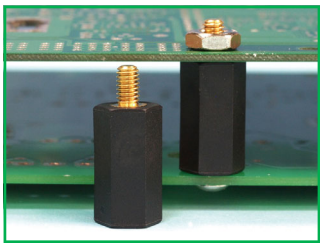
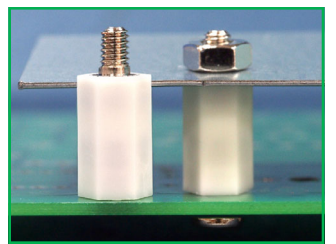
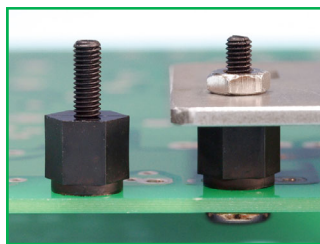
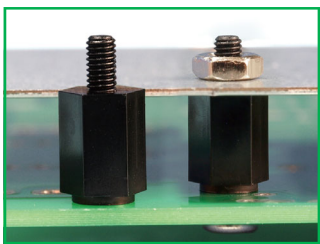
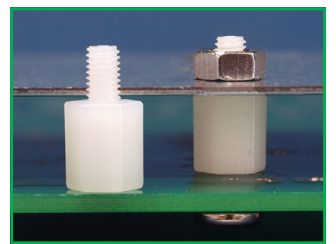
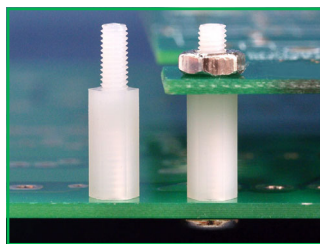
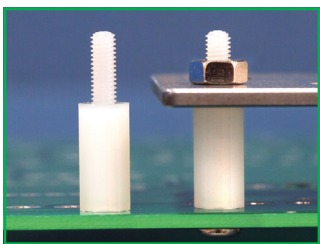
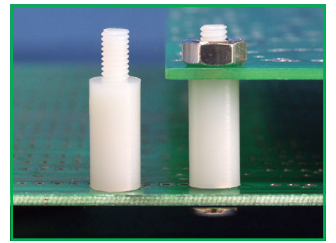
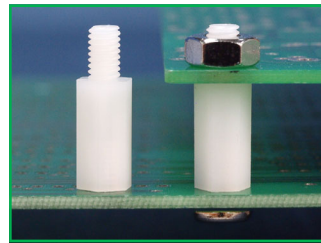
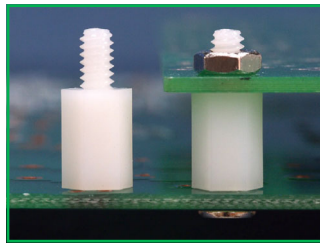
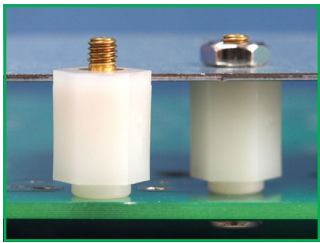
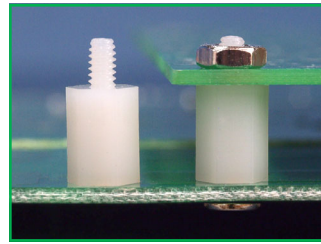
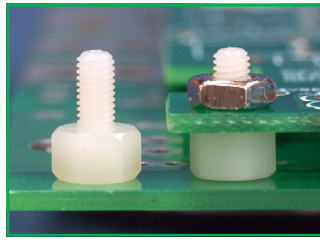
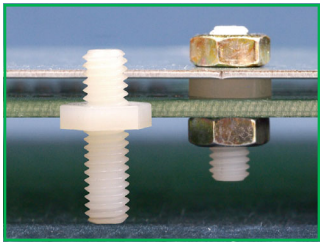
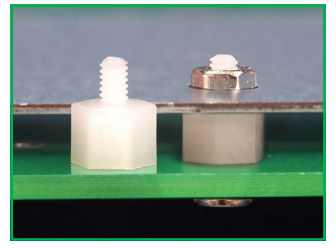
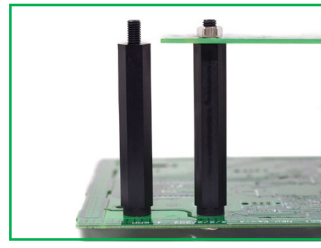
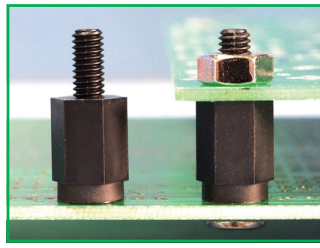
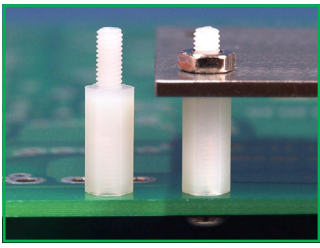

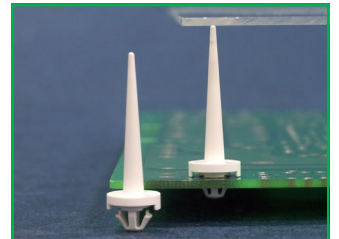
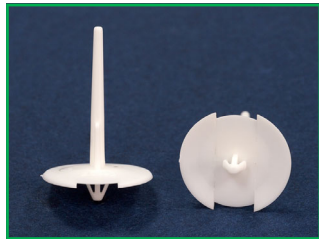
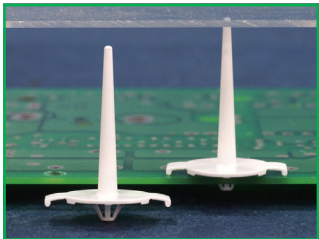
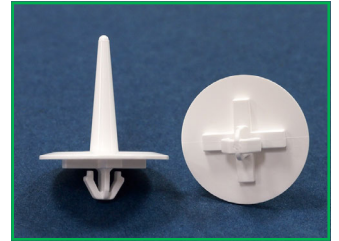
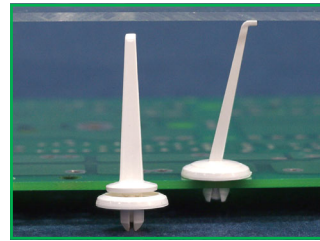
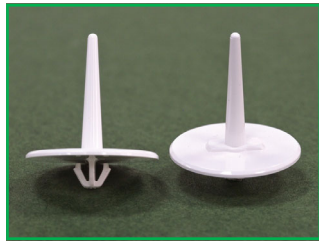
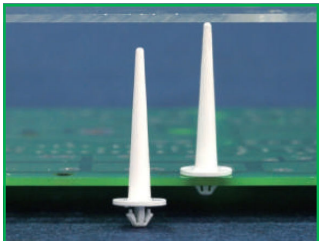
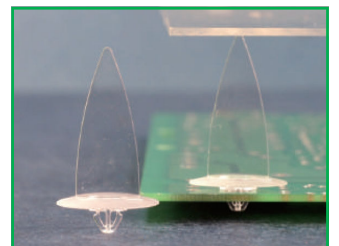
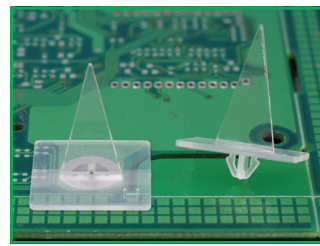
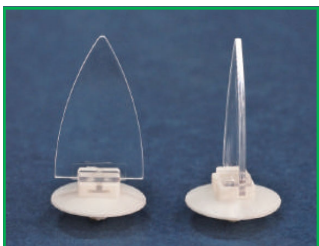
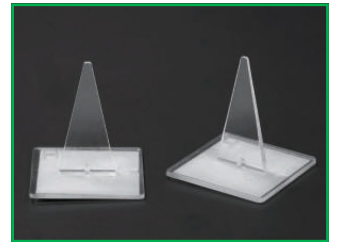
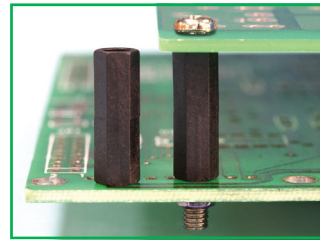
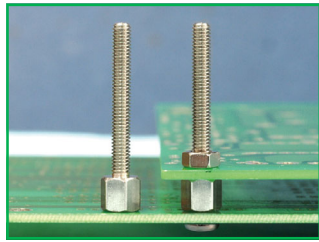
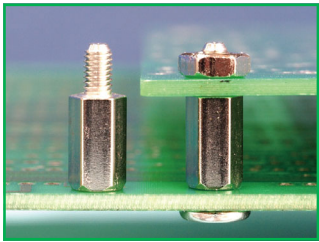
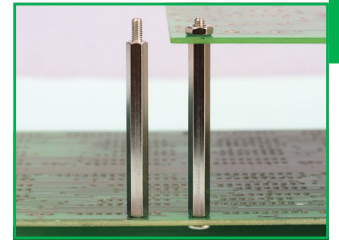
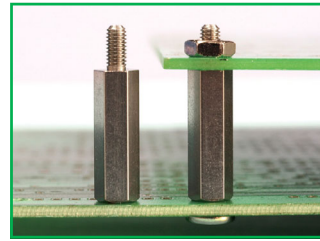
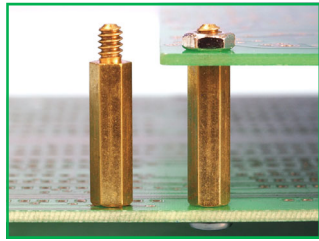
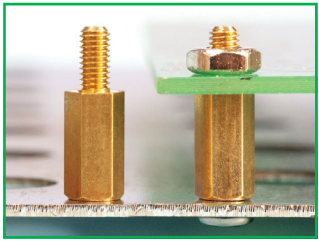
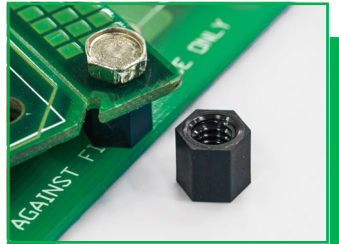
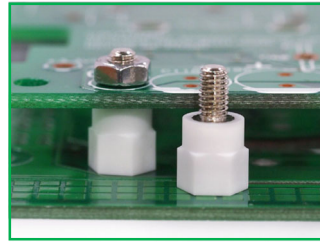
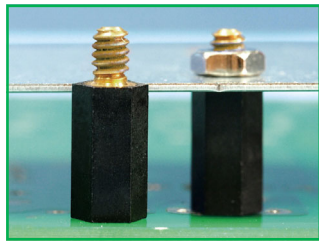
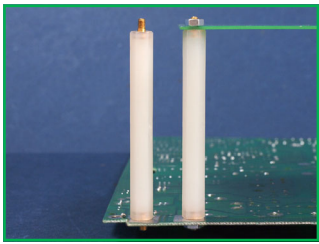
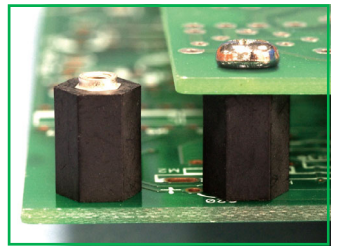
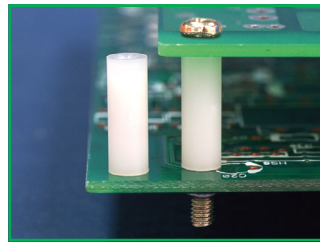
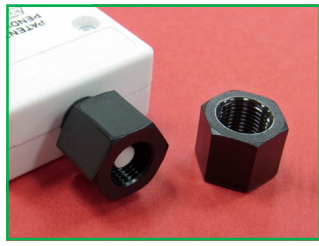
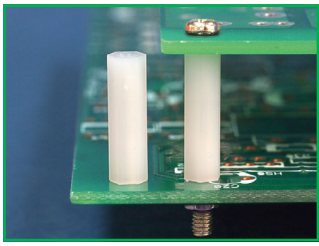

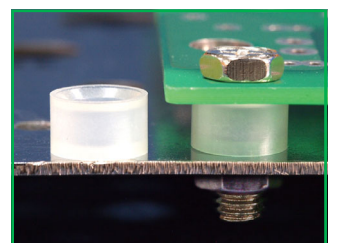
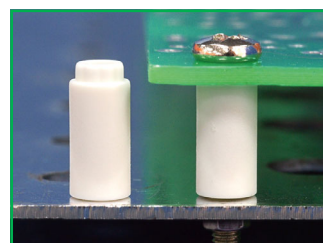
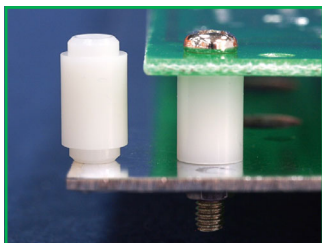
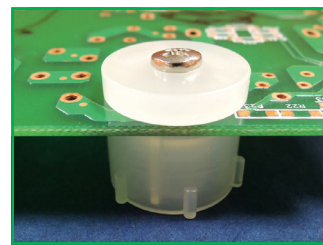
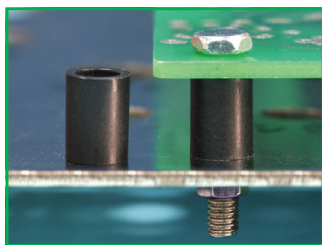
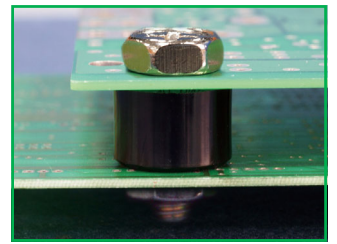
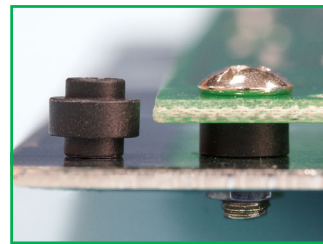
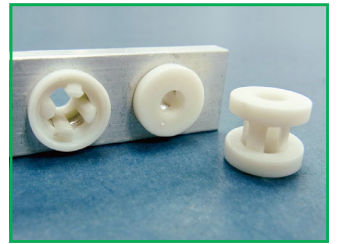
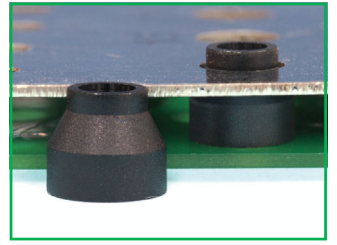
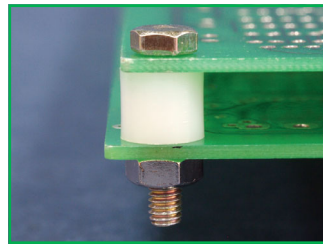
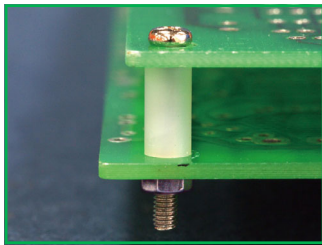
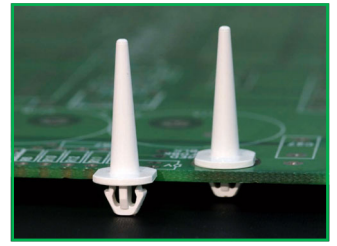
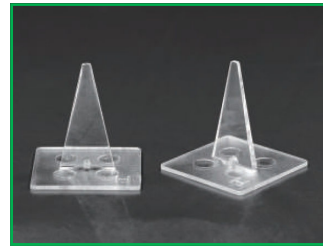
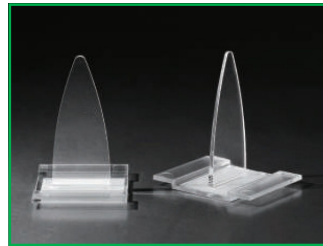
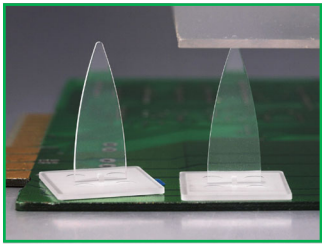
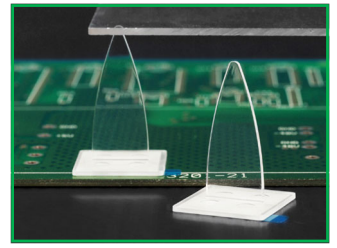
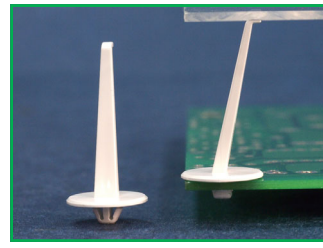
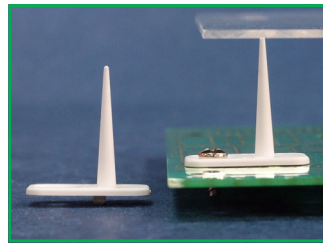
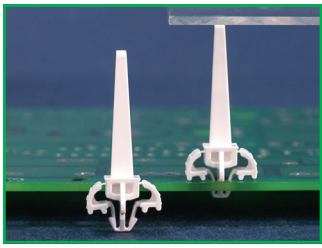

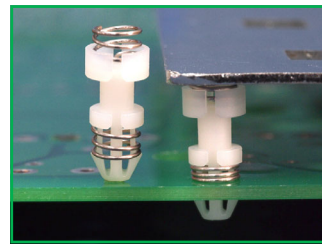
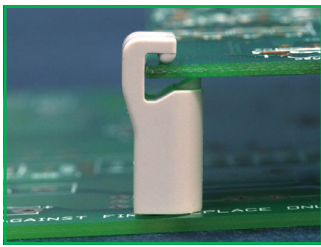
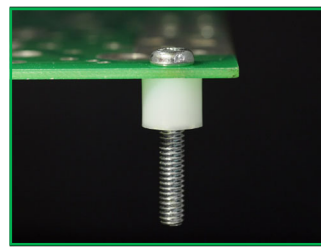
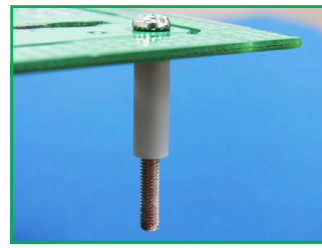
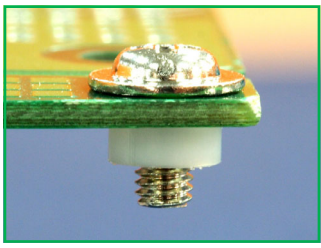
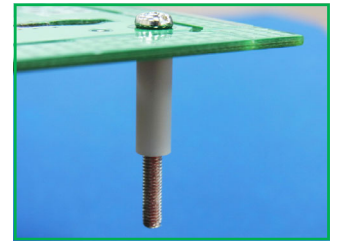
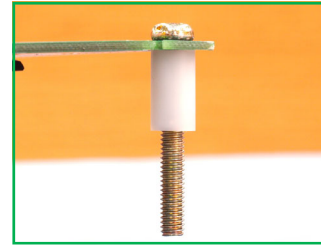
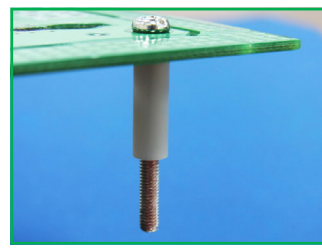
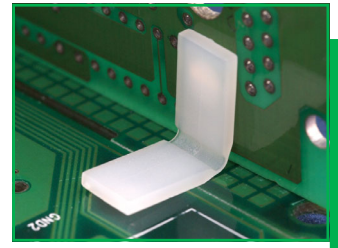
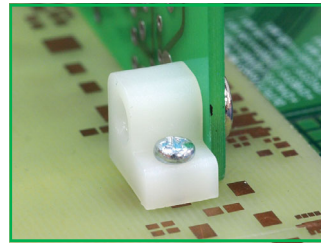
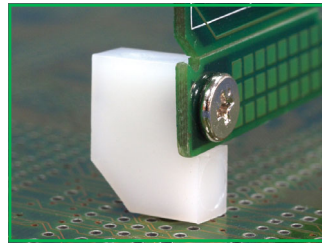
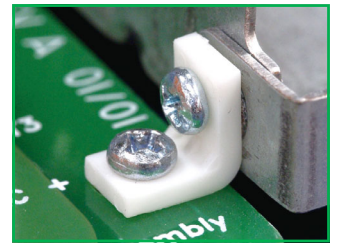
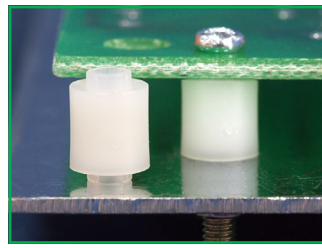
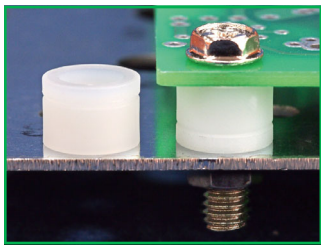

PC板塑料铜柱



# 塑料铜柱 FEMALE-FEMALE STANDOFF 尼龙柱 六角隔离柱 塑胶铜柱

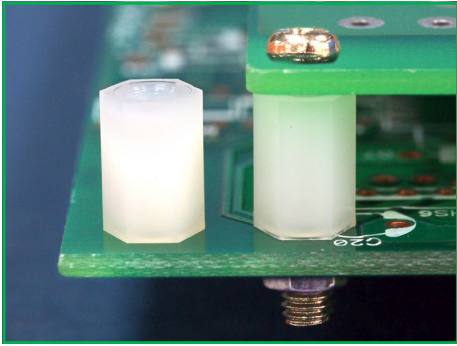

- ◆ MATERIAL : NYLON 66(UL)
- ◆ FLAME CLASS : 94V-2,94V-0
- ◆ COLOR : BLACK/NATURAL
- ◆ UNIT: mm

用途：塑料铜柱作为电路板与机板间之固定，六角型不滑动。

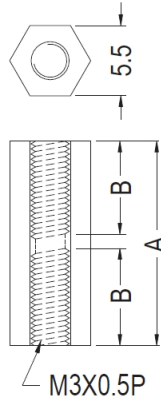
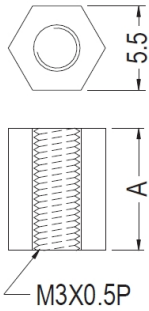

PART NO	A	PACKAGE
HTS-1	4.0	1000
HTS-2	5.0	1000
HTS-3	6.0	1000
HTS-4	7.0	1000
HTS-5	8.0	1000
HTS-6	9.0	1000
HTS-7	9.5	1000
HTS-8	10.0	1000
HTS-9	10.5	1000
HTS-10	11.0	1000
HTS-11	12.0	1000
HTS-13	12.7	1000
HTS-301	6.35	1000
HTS-302	8.5	1000

PART NO	A	B	PACKAGE
HTS-14	13.5	6.0	1000
HTS-15	14.0	6.0	1000
HTS-16	15.0	6.0	1000
HTS-17	16.0	6.0	1000
HTS-18	16.5	6.0	1000
HTS-19	17.0	6.0	1000
HTS-20	18.0	6.0	1000
HTS-21	19.0	6.0	1000
HTS-22	20.0	6.0	1000
HTS-23	22.0	6.0	1000
HTS-24	24.0	6.0	1000
HTS-25	25.0	6.0	1000
HTS-514	28.0	6.0	1000

PART NO	A	B	PACKAGE
HTS-26	27.0	6.0	1000
HTS-27	28.6	6.0	1000
HTS-28	30.0	6.0	1000
HTS-29	32.0	6.0	1000
HTS-30	38.0	6.0	500
HTS-31	40.0	6.0	500
HTS-32	42.0	6.0	500
HTS-33	45.0	6.0	500
HTS-34	47.0	6.0	500
HTS-35	49.0	6.0	500
HTS-36	52.0	6.0	500
HTS-37	54.0	6.0	500
HTS-293	14.5	6.0	1000
HTS-294	15.5	6.0	1000
HTS-295	35.0	6.0	1000
HTS-296	55.5	8.0	500
HTS-297	76.7	8.5	500
HTS-298	26.0	6.0	1000
HTS-299	21.5	6.0	1000
HTS-300	30.8	6.0	1000
HTS-350	60.2	6.0	500
HTS-351	37.0	6.0	1000
HTS-458	17.5	6.0	1000
HTS-459	50.0	6.0	500
HTS-515	70.0	10.0	500

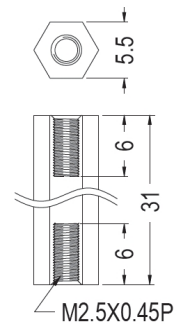
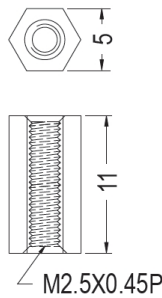
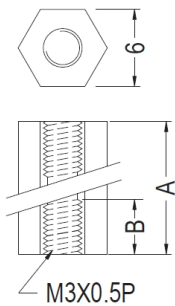

PART NO	A	B	PACKAGE
HTS-12	34.0	8.0	1000

PART NO	PACKAGE
HTS-352	1000

PART NO	PACKAGE
HTS-341	1000



# 塑料铜柱 FEMALE-FEMALE STANDOFF 尼龙柱 六角隔离柱 塑胶铜柱

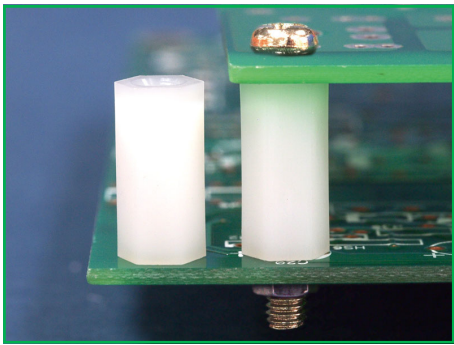

- ◆ MATERIAL : NYLON 66(UL)
- ◆ FLAME CLASS : 94V-2,94V-0
- ◆ COLOR : BLACK/NATURAL
- ◆ UNIT: mm

用途：塑料铜柱作为电路板与机板间之固定，六角型不滑动。

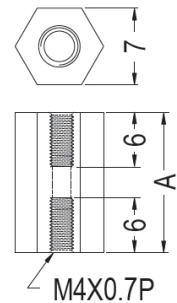
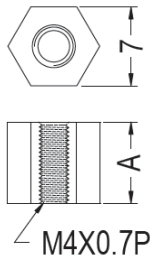
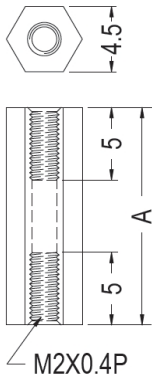

PC板塑料铜柱

PART NO	A	PACKAGE
HTS-64	13.0	1000
HTS-65	14.0	1000
HTS-66	15.0	1000
HTS-67	16.0	1000
HTS-68	17.0	1000
HTS-69	18.0	1000
HTS-70	19.0	1000
HTS-71	20.0	1000
HTS-72	21.0	1000
HTS-73	22.0	1000
HTS-74	23.0	1000
HTS-75	24.0	1000
HTS-76	25.0	1000
HTS-77	26.0	1000
HTS-78	27.0	1000
HTS-79	28.0	1000
HTS-292	18.8	1000

PART NO	A	PACKAGE
HTS-38	6.0	1000
HTS-39	7.0	1000
HTS-40	8.0	1000
HTS-41	9.0	1000
HTS-42	10.0	1000
HTS-43	11.0	1000
HTS-44	12.0	1000
HTS-45	12.7	1000

PART NO	A	PACKAGE
HTS-46	14.0	1000
HTS-47	16.0	1000
HTS-48	20.0	1000
HTS-49	25.0	1000
HTS-50	26.0	1000
HTS-51	30.0	1000
HTS-52	35.0	1000
HTS-53	40.0	1000
HTS-54	45.5	1000
HTS-461	45.0	1000

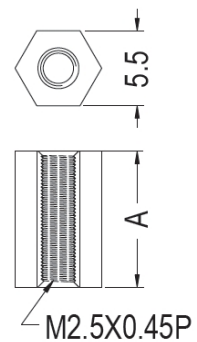
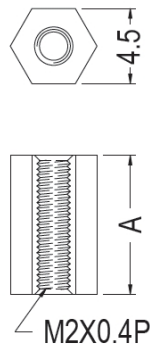

PART NO	A	PACKAGE
HTS-55	4.0	1000
HTS-56	5.0	1000
HTS-57	6.0	1000
HTS-58	7.0	1000
HTS-59	8.0	1000
HTS-60	9.0	1000
HTS-61	10.0	1000
HTS-62	11.0	1000
HTS-63	12.0	1000

PART NO	A	PACKAGE
HTS-451	10.0	1000
HTS-457	8.0	1000

塑料铜柱 FEMALE-FEMALE STANDOFF 尼龙柱 六角隔离柱 塑胶铜柱



- ◆ MATERIAL : PC+ABS(UL)
- ◆ FLAME CLASS : 94V-0
- ◆ COLOR : BLACK
- ◆ UNIT: mm

用途：塑料铜柱作为牙管的延伸与对接。

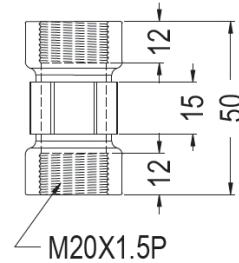
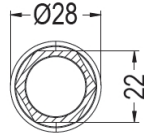

PART NO	PACKAGE
HTS-80	1000

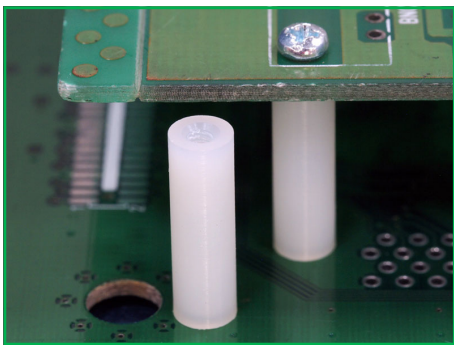

- ◆ MATERIAL : NYLON 66(UL)
- ◆ FLAME CLASS : 94V-2,94V-0
- ◆ COLOR : BLACK/NATURAL
- ◆ UNIT: mm

用途：塑料铜柱作为电路板与机板间之固定。

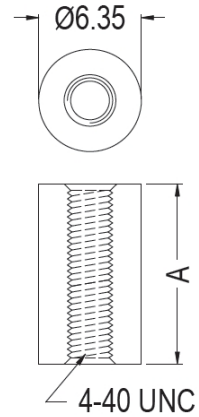
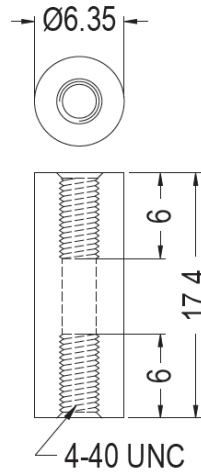
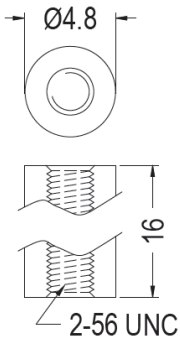

PART NO	PACKAGE
HTS-81	1000

PART NO	PACKAGE
HTS-105	1000

PART NO	A	PACKAGE
HTS-332	11.2	1000
HTS-334	6.35	1000

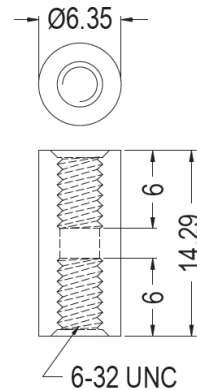
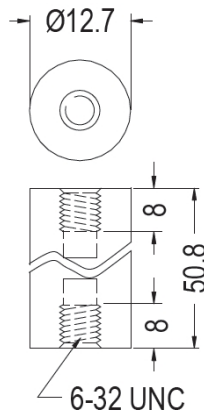
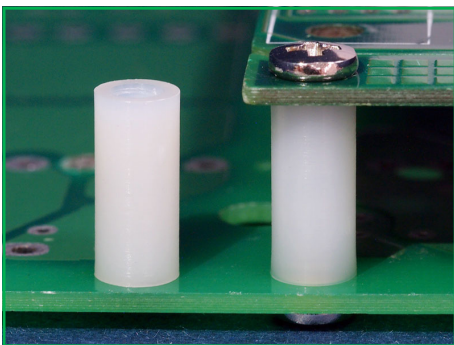

PART NO	PACKAGE
HTS-82	200

PART NO	PACKAGE
HTS-84	1000

# 塑料铜柱 FEMALE-FEMALE STANDOFF 尼龙柱 六角隔离柱 塑胶铜柱

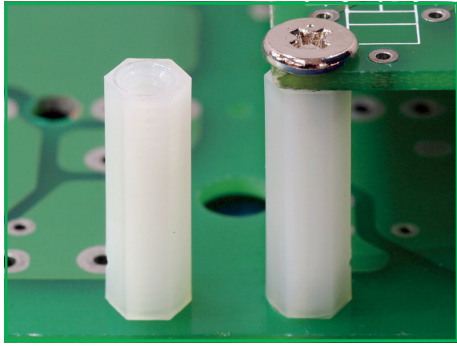

- ◆ MATERIAL : NYLON 66(UL)
- ◆ FLAME CLASS : 94V-2,94V-0
- ◆ COLOR : BLACK/NATURAL
- ◆ UNIT: mm

用途：塑料铜柱作为电路板与机板间之固定，六角型不滑动。

PC板塑料铜柱

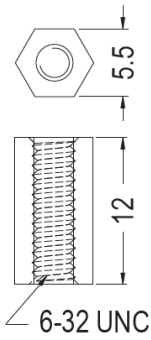

PART NO	PACKAGE
HTS-83	1000

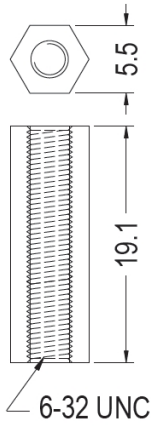

PART NO	PACKAGE
HTS-403	1000

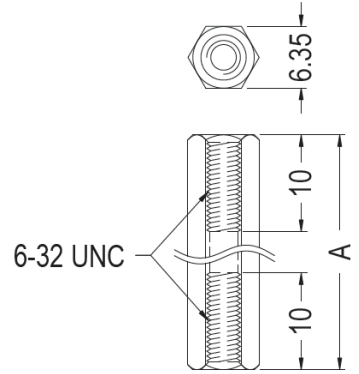

PART NO	A	PACKAGE
HTS-303	28.5	1000
HTS-304	38.1	1000
HTS-305	31.8	1000

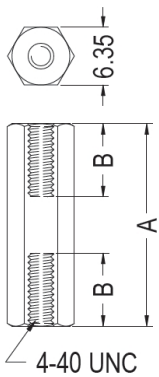

PART NO	A	B	PACKAGE
HTS-404	22.2	9.0	1000
HTS-405	28.6	6.4	1000
HTS-435	23.8	6.4	1000
HTS-436	25.4	9.0	1000

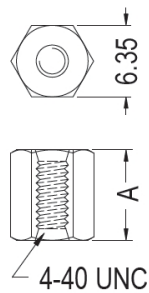

PART NO	A	PACKAGE
HTS-347	8.0	1000
HTS-478	6.35	1000
HTS-479	9.5	1000
HTS-480	12.7	1000
HTS-481	15.9	1000
HTS-482	19.1	1000

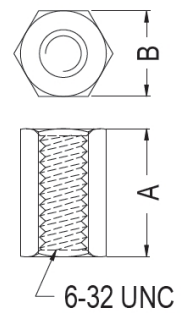

PART NO	A	B	PACKAGE
HTS-92	9.5	6.35	1000
HTS-93	12.7	6.35	1000
HTS-366	25.4	6.40	1000
HTS-367	6.4	6.35	1000
HTS-462	15.9	6.35	1000
HTS-483	19.1	6.35	1000
HTS-484	22.2	6.35	1000

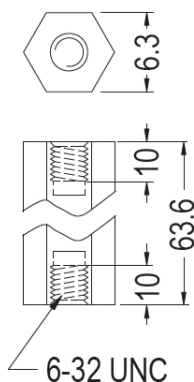
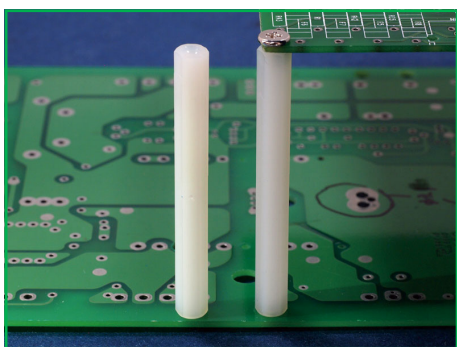

PART NO	PACKAGE
HTS-90	250

塑料铜柱 FEMALE-FEMALE STANDOFF 尼龙柱 六角隔离柱 塑胶铜柱

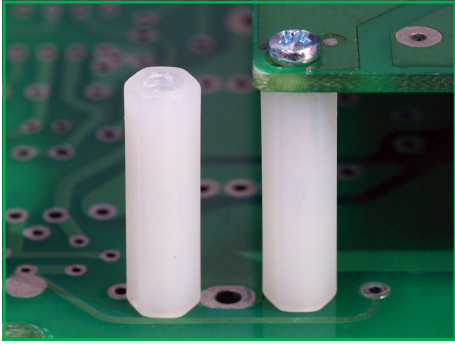

- ◆ MATERIAL : NYLON 66(UL)
- ◆ FLAME CLASS : 94V-2,94V-0
- ◆ COLOR : BLACK/NATURAL
- ◆ UNIT: mm

用途：塑料铜柱作为电路板与机板间之固定，六角型不滑动。

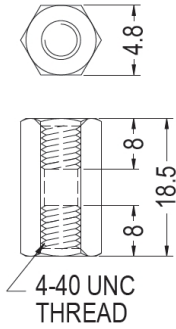

PART NO	PACKAGE
HTS-85	1000

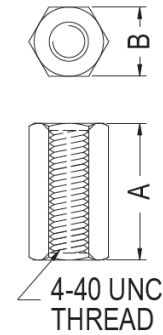
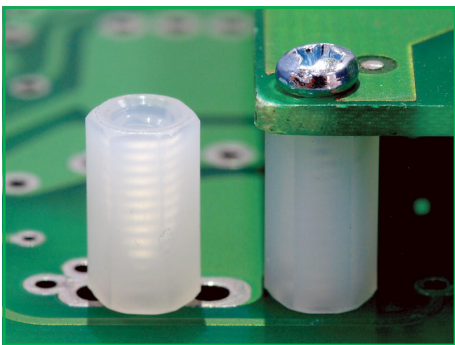

PART NO	A	B	PACKAGE
HTS-86	7.9	4.75	1000
HTS-313	15.88	4.75	1000
HTS-346	9.5	4.8	1000

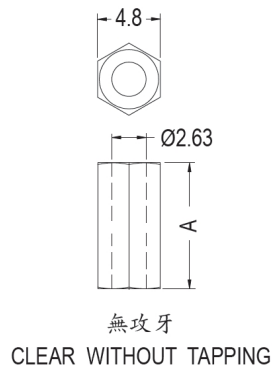
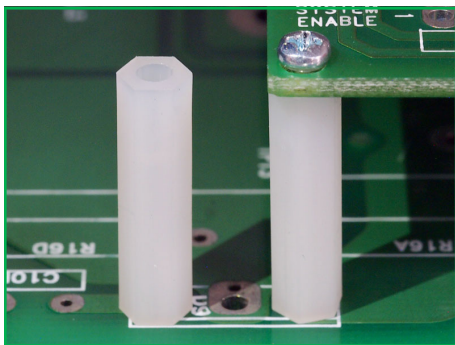

PART NO	A	PACKAGE
HTS-87	20.0	1000
HTS-88	32.0	1000

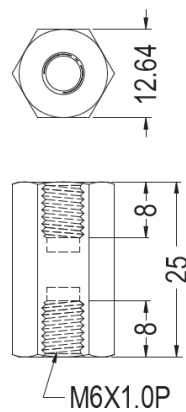
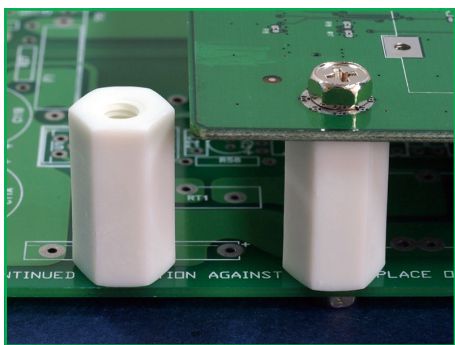

PART NO	PACKAGE
HTS-89	500

PC板塑料铜柱

塑料铜柱 FEMALE-FEMALE STANDOFF 尼龙柱 六角隔离柱 塑胶铜柱

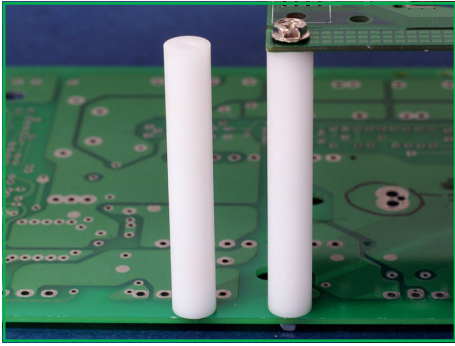

- ◆ MATERIAL : POM(UL)
- ◆ FLAME CLASS : 94HB
- ◆ COLOR : NATURAL
- ◆ UNIT: mm

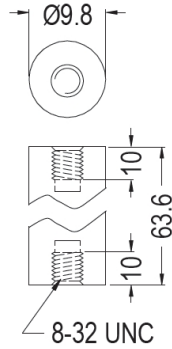

用途：塑料铜柱作为电路板与机板间之固定。

PART NO	PACKAGE
HTS-91	250

PC板塑料铜柱

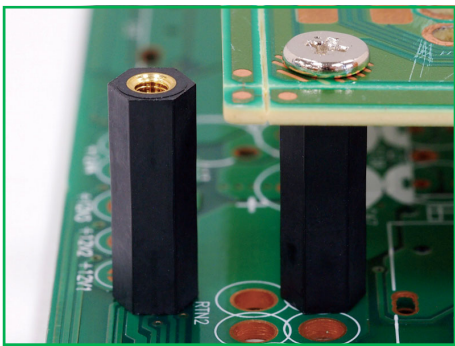

- ◆ MATERIAL : NYLON 66(UL)
- ◆ FLAME CLASS : 94V-2,94V-0
- ◆ COLOR : BLACK/NATURAL
- ◆ UNIT: mm

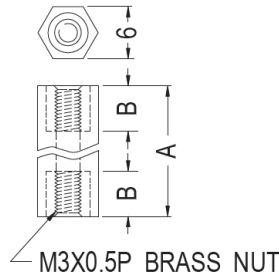

用途：塑料铜柱作为电路板与机板间之固定，六角型不滑动。

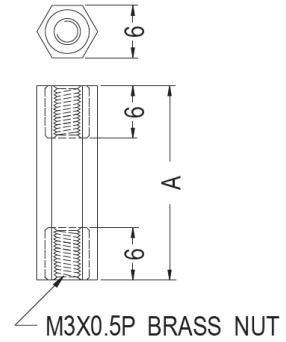

PART NO	A	B	PACKAGE
HTS-94	15.0	4.5	1000
HTS-310	11.9	4.0	1000

PART NO	A	PACKAGE
HTS-96	30.0	1000
HTS-311	19.0	1000
HTS-312	45.0	1000

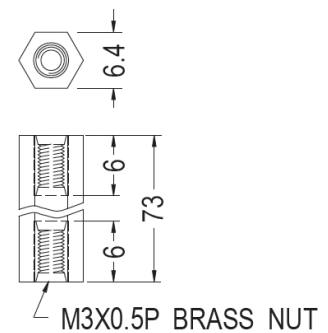
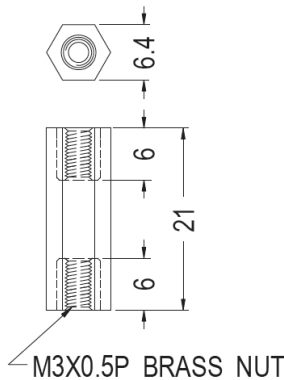
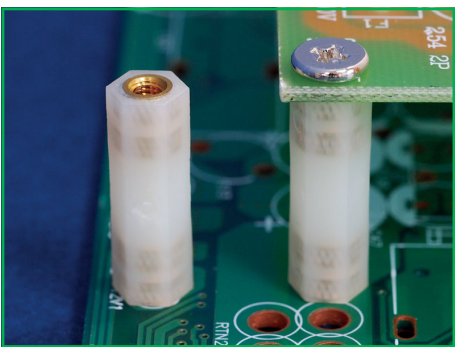

PART NO	PACKAGE
HTS-97	1000

PART NO	PACKAGE
HTS-95	1000

# 塑料铜柱 FEMALE-FEMALE STANDOFF 尼龙柱 六角隔离柱 塑胶铜柱

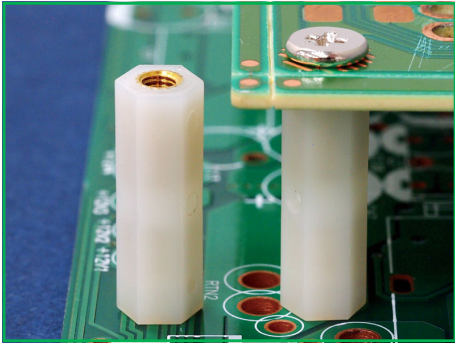

- ◆ MATERIAL : NYLON 66(UL)
- ◆ FLAME CLASS : 94V-2,94V-0
- ◆ COLOR : BLACK/NATURAL
- ◆ UNIT: mm

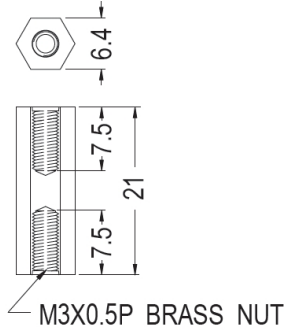

PART NO	PACKAGE
HTS-454	1000

用途：塑料铜柱作为电路板与机板间之固定，六角型不滑动。

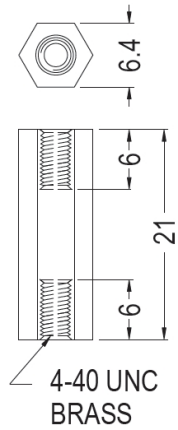

PART NO	PACKAGE
HTS-441	1000

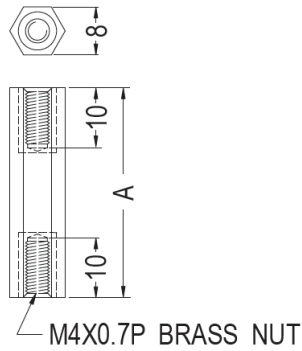
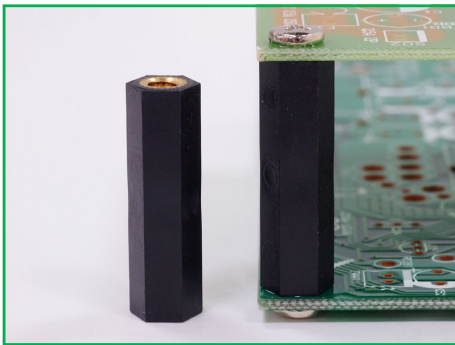

PART NO	A	PACKAGE
HTS-368	30.0	1000
HTS-431	35.0	1000
HTS-432	40.0	1000

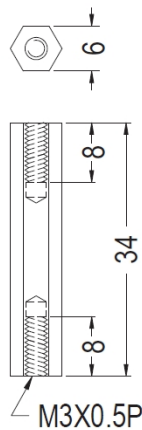
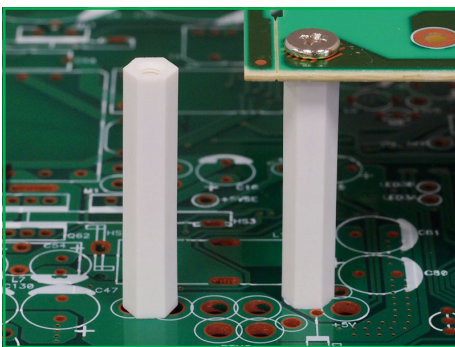

PART NO	PACKAGE
HTS-98	1000

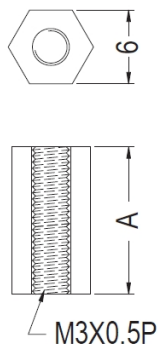
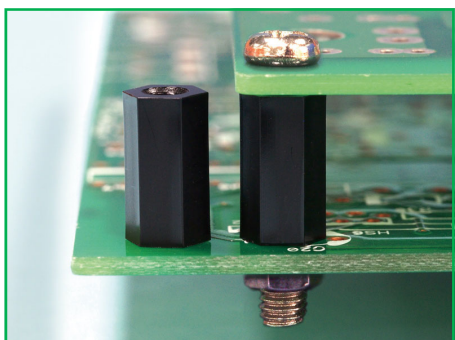

PART NO	A	PACKAGE
HTS-437	12.0	2000
HTS-438	10.0	2000
HTS-439	15.0	2000

# 塑料铜柱 FEMALE-FEMALE STANDOFF 尼龙柱 六角隔离柱 塑胶铜柱

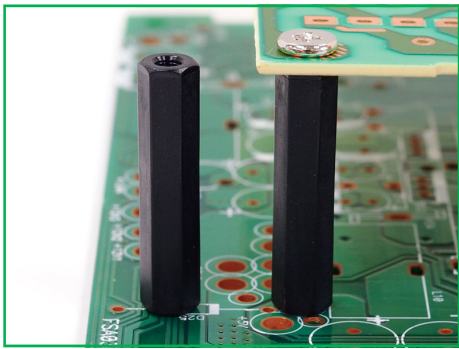

- ◆ MATERIAL : NYLON 66(UL)
- ◆ FLAME CLASS : 94V-2,94V-0
- ◆ COLOR : BLACK/NATURAL
- ◆ UNIT: mm

用途：塑料铜柱作为电路板与机板间之固定。

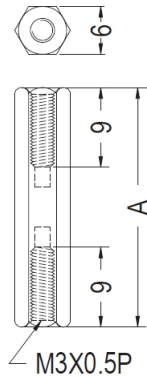
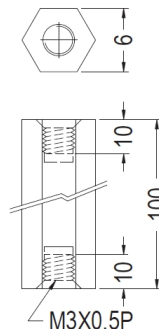

PART NO	PACKAGE
HTS-102	500

PART NO	A	PACKAGE
HTS-103	30.0	500
HTS-369	40.0	500

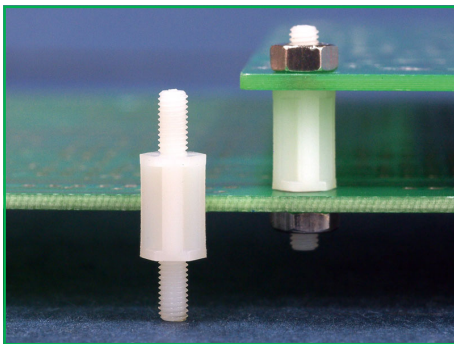

- ◆ MATERIAL : NYLON 66(UL)
- ◆ FLAME CLASS : 94V-2,94V-0
- ◆ COLOR : BLACK/NATURAL
- ◆ UNIT: mm

用途：塑料铜柱作为电路板与机板间之固定，两端配合攻牙或螺母使用。

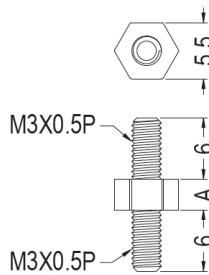
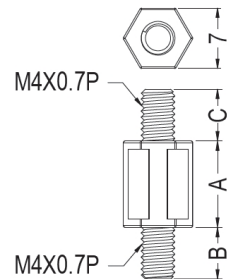
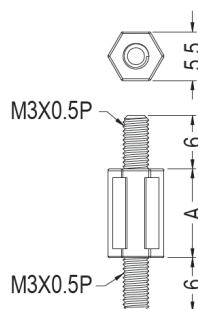

PART NO	A	PACKAGE
HTS-99	5.0	1000
HTS-100	10.0	1000
HTS-101	15.0	1000
HTS-471	5.5	1000

PART NO	A	B	C	PACKAGE
HTS-355	19.0	6.0	6.0	1000
HTS-356	5.0	6.0	6.0	1000
HTS-357	10.0	6.0	6.0	1000
HTS-358	15.0	8.0	8.0	1000
HTS-493	17.0	6.0	6.0	1000

PART NO	A	PACKAGE
HTS-394	3.0	1000
HTS-395	4.75	1000

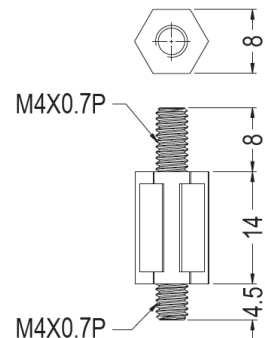
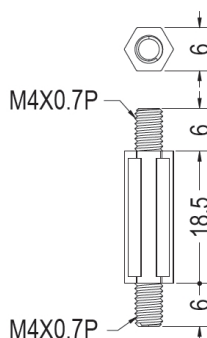
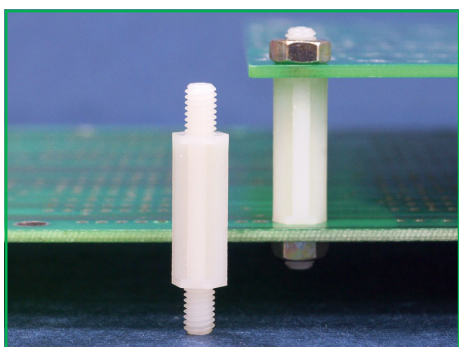

PART NO	PACKAGE
HTS-450	1000

PART NO	PACKAGE
HTS-472	1000

塑料铜柱 FEMALE-FEMALE STANDOFF 尼龙柱 六角隔离柱 塑胶铜柱

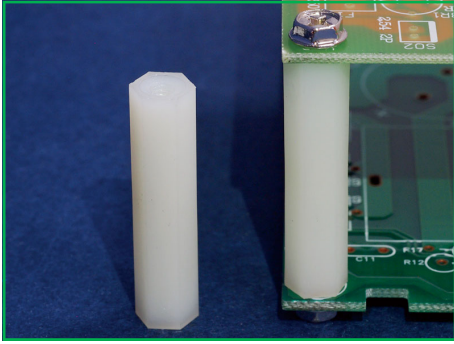

- ◆ MATERIAL : NYLON 66(UL)
- ◆ FLAME CLASS : 94V-2,94V-0
- ◆ COLOR : BLACK/NATURAL
- ◆ UNIT: mm

用途：塑料铜柱作为电路板与机板间之固定，六角型不滑动。

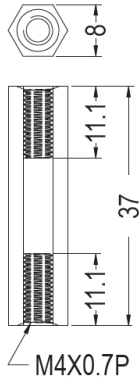

PART NO	PACKAGE
HTS-104	1000

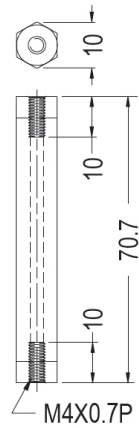
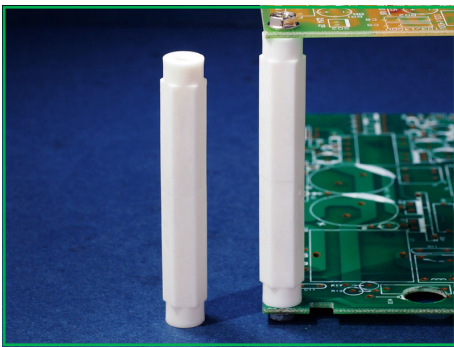

PART NO	PACKAGE
HTS-363	500

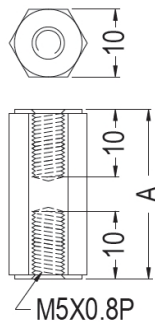
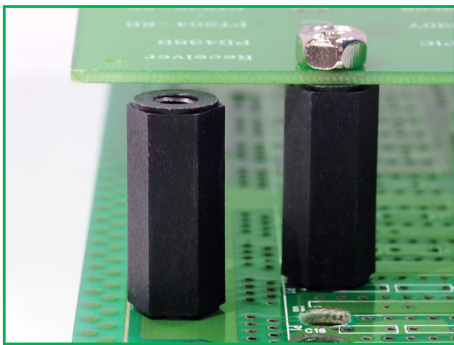

PART NO	A	PACKAGE
HTS-400	45.0	500
HTS-443	25.0	1000

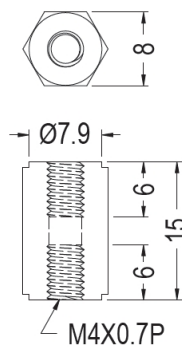
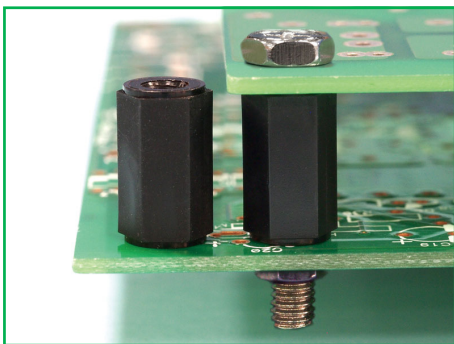

PART NO	PACKAGE
HTS-106	1000

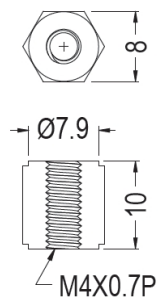

PART NO	PACKAGE
HTS-314	1000

PC板塑料铜柱



# 塑料铜柱 FEMALE-FEMALE STANDOFF 尼龙柱 六角隔离柱 塑胶铜柱

PC板塑料铜柱

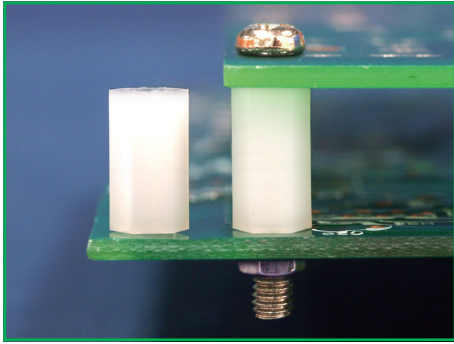

- ◆ MATERIAL : NYLON 66(UL)
- ◆ FLAME CLASS : 94V-2,94V-0
- ◆ COLOR : BLACK/NATURAL
- ◆ UNIT: mm

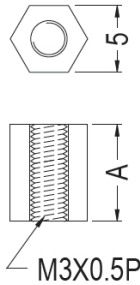

PART NO	A	PACKAGE
HTS-107	6.0	1000
HTS-108	8.0	1000
HTS-109	10.0	1000
HTS-110	12.0	1000

用途：塑料铜柱作为电路板与机板间之固定。

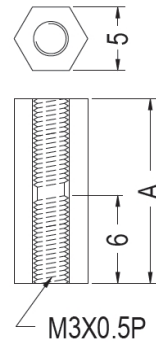

PART NO	A	PACKAGE
HTS-111	15.0	1000
HTS-112	18.0	1000
HTS-113	20.0	1000
HTS-114	25.0	1000
HTS-364	17.4	1000

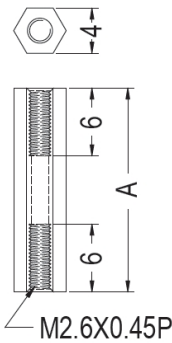
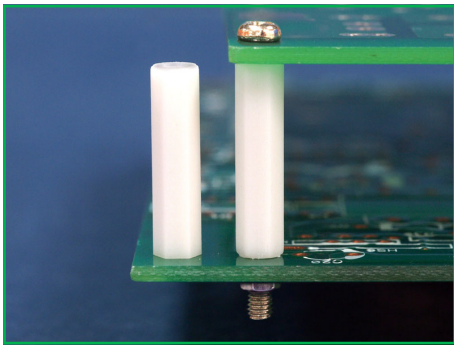

PART NO	A	PACKAGE
HTS-452	18.0	1000
HTS-453	19.0	1000
HTS-401	31.75	1000

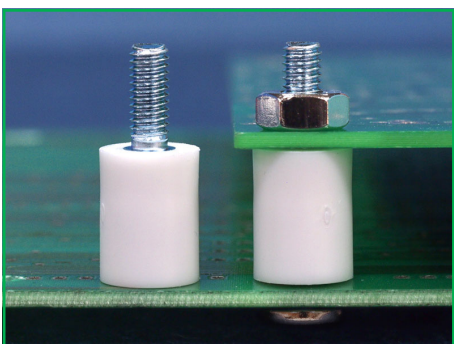

- ◆ MATERIAL : NYLON 66(UL)
- ◆ FLAME CLASS : 94V-2,94V-0
- ◆ COLOR : BLACK/NATURAL
- ◆ UNIT: mm

用途：塑料铜柱作为电路板与机板间之固定，一端配合螺丝，另一端配合螺帽使用。

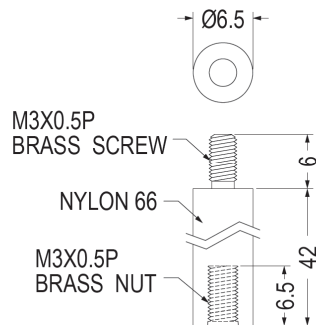

PART NO	PACKAGE
HTS-497	1000

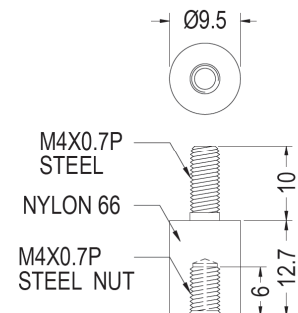

PART NO	PACKAGE
HTS-115	1000

# 塑料铜柱 FEMALE-FEMALE STANDOFF 尼龙柱 六角隔离柱 塑胶铜柱

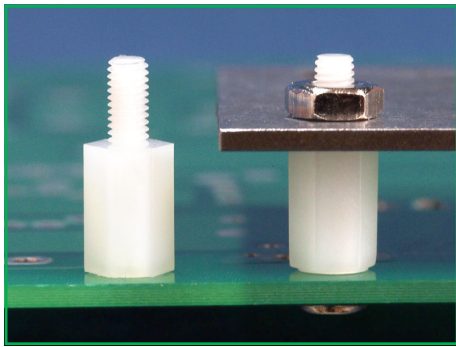

- ◆ MATERIAL : NYLON 66(UL)
- ◆ FLAME CLASS : 94V-2,94V-0
- ◆ COLOR : BLACK/NATURAL
- ◆ UNIT: mm

用途：塑料铜柱作为电路板与机板间之固定，一端配合螺丝，另一端配合螺帽使用。

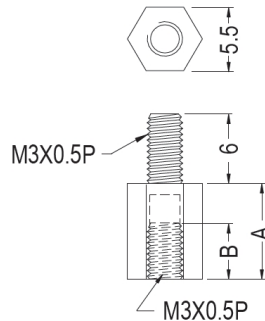

PART NO	A	B	PACKAGE
HTS-117	5.0	3.0	1000
HTS-118	6.0	4.0	1000
HTS-119	7.0	5.0	1000
HTS-120	7.5	5.0	1000
HTS-121	8.0	6.0	1000
HTS-122	9.0	6.0	1000
HTS-123	10.	6.0	1000
HTS-124	10.5	6.0	1000
HTS-125	11.0	6.0	1000
HTS-126	12.0	6.0	1000
HTS-127	12.7	6.0	1000
HTS-128	13.0	6.0	1000
HTS-129	14.0	6.0	1000
HTS-130	15.0	6.0	1000

PART NO	A	B	PACKAGE
HTS-131	15.5	6.0	1000
HTS-132	16.0	6.0	1000
HTS-133	16.5	6.0	1000
HTS-134	17.0	6.0	1000
HTS-135	18.0	6.0	1000
HTS-136	18.5	6.0	1000
HTS-137	19.0	6.0	1000
HTS-138	20.0	6.0	1000
HTS-139	21.0	6.0	1000
HTS-140	22.0	6.0	1000

PART NO	A	B	PACKAGE
HTS-141	24.5	6.0	1000
HTS-142	25.0	6.0	1000
HTS-143	27.0	6.0	1000
HTS-144	28.5	6.0	1000
HTS-145	30.0	6.0	1000
HTS-146	33.3	6.0	1000
HTS-147	34.5	6.0	1000
HTS-148	35.0	6.0	1000
HTS-149	40.0	6.0	1000
HTS-150	45.0	6.0	1000
HTS-151	53.5	6.0	1000
HTS-319	4.0	3.0	1000
HTS-320	8.5	6.0	1000
HTS-321	36.0	6.0	1000
HTS-322	55.5	8.0	1000
HTS-323	28.0	6.0	1000
HTS-393	9.5	6.0	1000
HTS-464	10.8	6.0	1000
HTS-487	37.0	6.0	1000

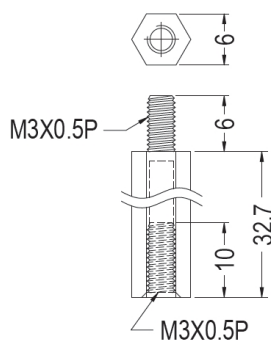

ART NO	PACKAGE
HTS-329	1000

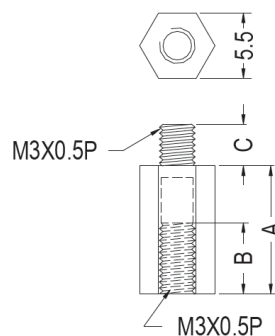

PART NO	A	B	C	PACKAGE
HTS-152	5.0	4.0	3.5	1000
HTS-153	5.0	4.0	5.0	1000
HTS-154	7.0	5.0	4.0	1000
HTS-155	9.0	6.0	4.0	1000
HTS-156	10.8	6.0	3.5	1000
HTS-157	11.2	6.0	3.5	1000
HTS-324	6.0	4.0	5.0	1000
HTS-325	16.0	6.0	4.0	1000
HTS-326	18.0	6.0	5.0	1000
HTS-327	20.0	8.0	5.0	1000

# 塑料铜柱 FEMALE-FEMALE STANDOFF 尼龙柱 六角隔离柱 塑胶铜柱

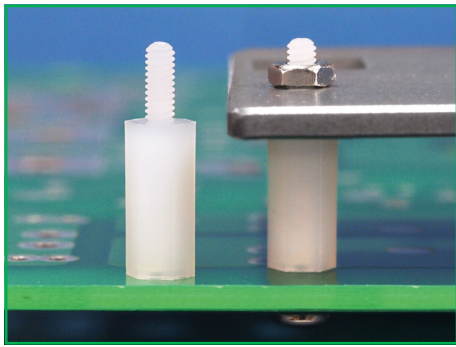

- ◆ MATERIAL : NYLON 66(UL)
- ◆ FLAME CLASS : 94V-2,94V-0
- ◆ COLOR : BLACK/NATURAL
- ◆ UNIT: mm

用途：塑料铜柱作为电路板与机板间之固定，一端配合螺丝，另一端配合螺帽使用。

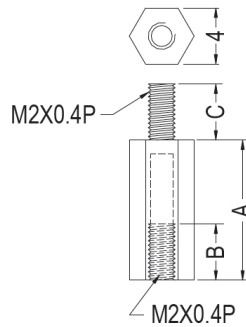

PART NO	A	B	C	PACKAGE
HTS-372	23.0	5.0	5.0	1000
HTS-373	22.0	5.0	5.0	1000
HTS-374	24.0	5.0	5.0	1000
HTS-375	6.0	4.0	5.0	1000
HTS-376	7.0	4.0	5.0	1000
HTS-377	6.5	4.0	5.0	1000
HTS-378	6.5	4.0	4.0	1000
HTS-379	25.0	5.0	5.0	1000
HTS-380	26.0	5.0	5.0	1000
HTS-381	27.0	5.0	5.0	1000
HTS-382	4.0	2.5	5.0	1000
HTS-383	9.0	5.0	5.0	1000
HTS-384	11.0	5.0	5.0	1000
HTS-385	12.0	5.0	5.0	1000
HTS-386	13.0	5.0	5.0	1000
HTS-387	16.0	5.0	5.0	1000
HTS-388	17.0	5.0	5.0	1000
HTS-389	18.0	5.0	5.0	1000
HTS-390	19.0	5.0	5.0	1000
HTS-391	20.0	5.0	5.0	1000

PART NO	A	B	C	PACKAGE
HTS-158	5.0	3.0	5.0	1000
HTS-159	5.0	3.0	4.0	1000
HTS-160	5.5	3.0	5.0	1000
HTS-161	8.0	5.0	5.0	1000
HTS-162	8.0	4.0	4.0	1000
HTS-163	10.0	5.0	5.0	1000
HTS-164	10.0	4.0	4.0	1000
HTS-165	14.0	5.0	5.0	1000
HTS-166	15.0	5.0	5.0	1000
HTS-167	15.0	4.0	4.0	1000
HTS-168	21.0	5.0	5.0	1000
HTS-169	28.0	5.0	5.0	1000

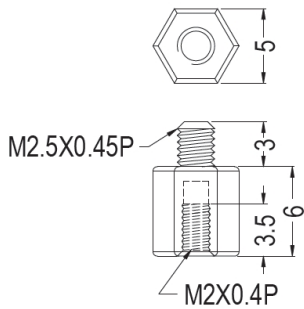

PART NO	PACKAGE
HTS-336	1000

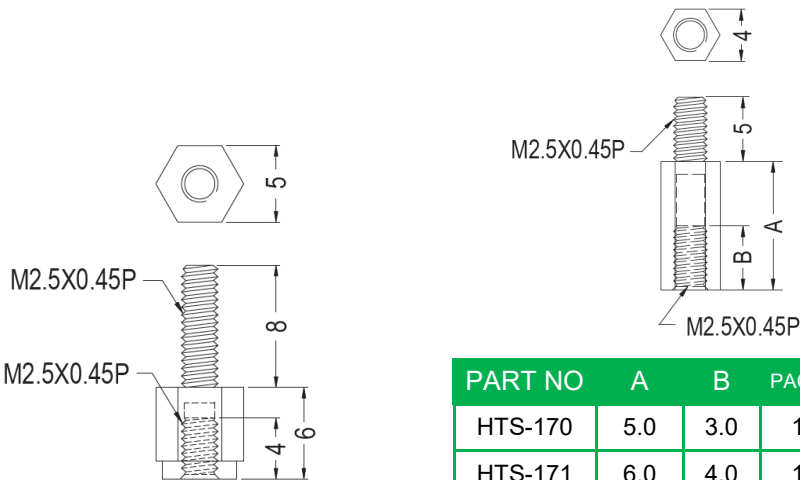

PART NO	PACKAGE
HTS-485	1000

PART NO	A	B	PACKAGE
HTS-170	5.0	3.0	1000
HTS-171	6.0	4.0	1000
HTS-172	7.0	5.0	1000
HTS-173	8.0	5.0	1000
HTS-174	9.0	5.0	1000
HTS-175	10.0	5.0	1000
HTS-176	11.0	5.0	1000
HTS-177	12.0	5.0	1000
HTS-178	13.0	5.0	1000

PART NO	A	B	PACKAGE
HTS-179	14.0	5.0	1000
HTS-180	15.0	5.0	1000
HTS-181	16.0	5.0	1000
HTS-182	17.0	5.0	1000
HTS-183	18.0	5.0	1000
HTS-184	19.0	5.0	1000
HTS-185	20.0	5.0	1000
HTS-186	21.0	5.0	1000
HTS-187	22.0	5.0	1000
HTS-188	23.0	5.0	1000
HTS-189	24.0	5.0	1000
HTS-190	25.0	5.0	1000
HTS-191	26.0	5.0	1000
HTS-192	27.0	5.0	1000
HTS-193	28.0	5.0	1000
HTS-486	24.5	5.0	1000

# 塑料铜柱 FEMALE-FEMALE STANDOFF 尼龙柱 六角隔离柱 塑胶铜柱

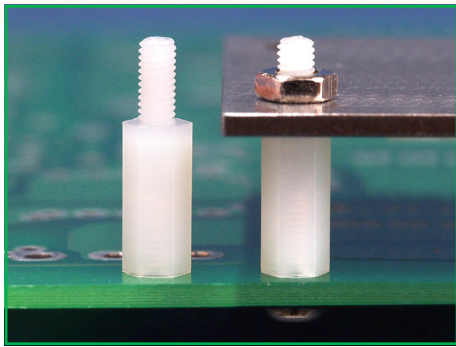

- ◆ MATERIAL : NYLON 66(UL)
- ◆ FLAME CLASS : 94V-2,94V-0
- ◆ COLOR : BLACK/NATURAL
- ◆ UNIT: mm

用途: 塑料铜柱作为电路板与机板间之固定, 一端配合螺丝, 另一端配合螺帽使用。

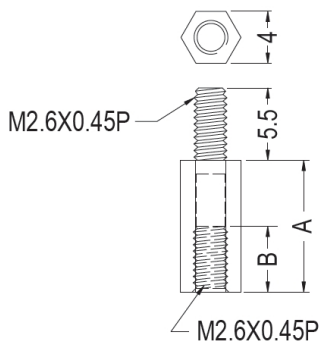

PART NO	A	B	PACKAGE
HTS-194	4.0	2.0	1000
HTS-195	5.0	3.0	1000
HTS-196	6.0	4.0	1000
HTS-197	7.0	5.0	1000
HTS-198	8.0	5.5	1000
HTS-199	9.0	5.5	1000
HTS-200	10.0	5.5	1000
HTS-201	11.0	5.5	1000
HTS-202	12.0	5.5	1000
HTS-203	13.0	5.5	1000
HTS-204	14.0	5.5	1000
HTS-205	15.0	5.5	1000
HTS-206	16.0	5.5	1000

PART NO	A	B	PACKAGE
HTS-207	17.0	5.5	1000
HTS-208	18.0	5.5	1000
HTS-209	19.0	5.5	1000
HTS-210	20.0	5.5	1000
HTS-211	21.0	5.5	1000
HTS-212	22.0	5.5	1000
HTS-213	23.0	5.5	1000
HTS-214	24.0	5.5	1000
HTS-215	24.0	5.5	1000
HTS-216	26.0	5.5	1000
HTS-217	27.0	5.5	1000
HTS-218	28.0	5.5	1000
HTS-392	12.7	5.5	1000

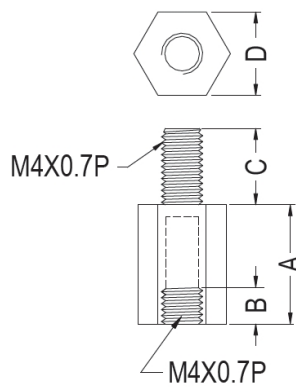
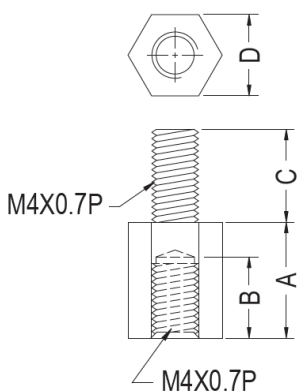

PART NO	A	B	C	D	PACKAGE
HTS-468	10.0	7.0	8.0	7.0	1000

PART NO	A	B	C	D	PACKAGE
HTS-220	10.0	7.0	8.0	8.0	1000
HTS-222	6.0	4.0	6.5	7.0	1000
HTS-223	8.0	6.0	6.5	7.0	1000
HTS-224	10.0	7.0	6.5	7.0	1000
HTS-225	12.0	6.0	6.5	7.0	1000
HTS-226	13.0	6.0	6.5	7.0	1000
HTS-227	14.0	6.0	6.5	7.0	1000
HTS-228	15.0	6.0	6.5	7.0	1000
HTS-229	16.0	7.0	6.5	7.0	1000
HTS-230	17.0	7.0	6.5	7.0	1000
HTS-231	19.0	7.0	6.5	7.0	1000
HTS-232	20.0	8.0	6.5	7.0	1000
HTS-233	25.0	8.0	6.5	7.0	1000
HTS-234	27.0	8.0	6.5	7.0	1000
HTS-235	30.0	8.0	6.5	7.0	1000
HTS-236	34.0	8.0	6.5	7.0	1000
HTS-237	35.0	8.0	6.5	7.0	1000
HTS-238	40.0	8.0	6.5	7.0	1000
HTS-239	45.0	8.0	6.5	7.0	1000
HTS-240	57.0	8.0	6.5	7.0	1000
HTS-328	37.0	8.0	6.5	7.0	1000

# 塑料铜柱 FEMALE-FEMALE STANDOFF 尼龙柱 六角隔离柱 塑胶铜柱

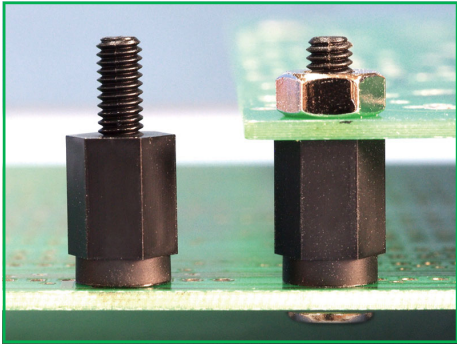

- ◆ MATERIAL : NYLON 66(UL)
- ◆ FLAME CLASS : 94V-2,94V-0
- ◆ COLOR : BLACK/NATURAL
- ◆ UNIT: mm

用途：塑料铜柱作为电路板与机板间之固定，一端配合螺丝，另一端配合螺帽使用。

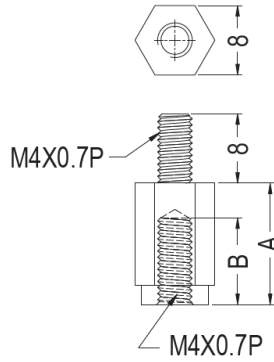

PART NO	A	B	PACKAGE
HTS-331	11.0	9.0	1000
HTS-345	14.0	10.0	1000
HTS-396	12.0	10.0	1000
HTS-397	20.0	10.0	1000
HTS-398	35.0	10.0	1000
HTS-399	32.0	10.0	1000
HTS-469	10.0	8.0	1000
HTS-488	8.0	6.0	1000

PC板塑料铜柱

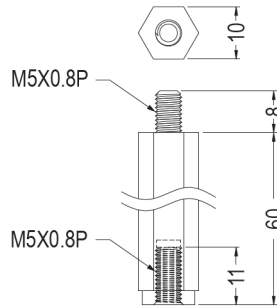
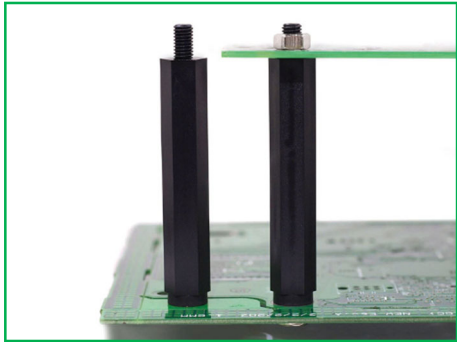

PART NO	PACKAGE
HTS-489	1000

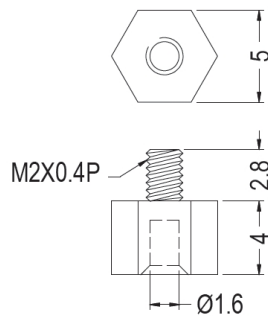
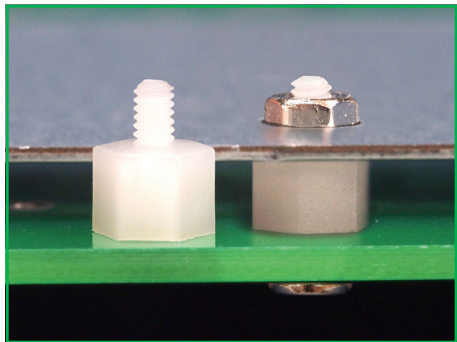

PART NO	PACKAGE
HTS-219	1000

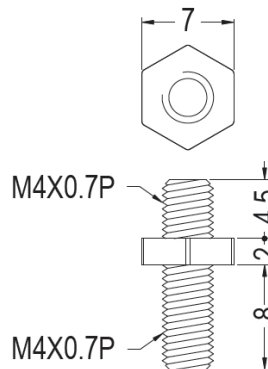
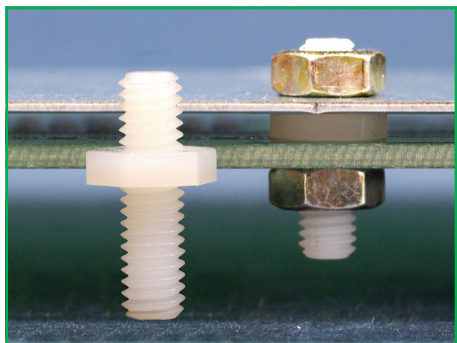

PART NO	PACKAGE
TPAA-02	1000

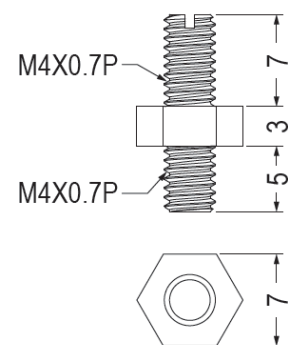

PART NO	PACKAGE
TPAA-03	1000

## 塑料螺柱 MALE STANDOFF 尼龙柱 六角隔离柱 塑胶铜柱

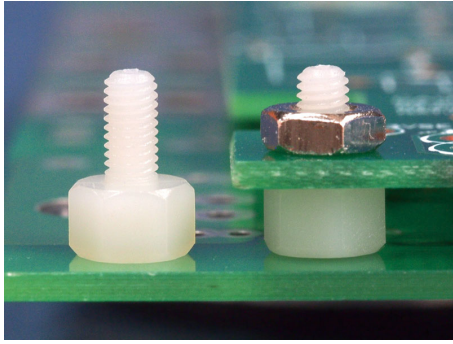

- ◆ MATERIAL : NYLON 66(UL)
- ◆ FLAME CLASS : 94V-2,94V-0
- ◆ COLOR : BLACK/NATURAL
- ◆ UNIT: mm

用途：塑料铜柱作为电路板与机板间垫高，一端放在机板上，另一端在PCB线路板端配合螺帽使用。

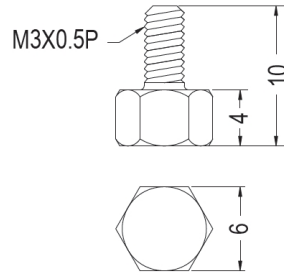

PART NO	PACKAGE
TPAA-01	1000

## 塑料铜柱 FEMALE-FEMALE STANDOFF 尼龙柱 六角隔离柱 塑胶铜柱

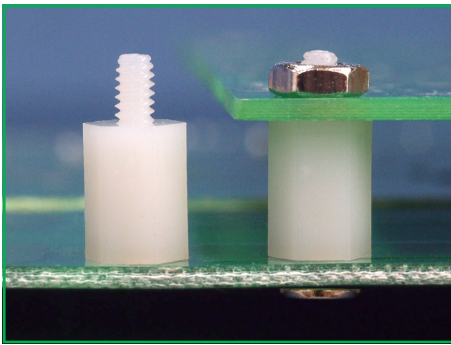

- ◆ MATERIAL : NYLON 66(UL)
- ◆ FLAME CLASS : 94V-2,94V-0
- ◆ COLOR : BLACK/NATURAL
- ◆ UNIT: mm

用途：塑料铜柱作为电路板与机板间之固定，一端配合螺丝，另一端配合螺帽使用。

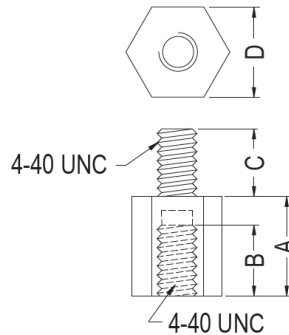

PART NO	A	B	C	D	PACKAGE
HTS-241	6.4	4.0	4.8	6.4	1000
HTS-242	7.0	4.0	4.8	6.4	1000
HTS-243	9.5	6.0	4.8	6.4	1000
HTS-244	12.7	6.0	4.8	6.4	1000
HTS-245	15.9	6.0	4.8	6.4	1000
HTS-246	19.1	6.0	4.8	6.4	1000
HTS-247	28.7	6.0	4.8	6.4	1000
HTS-248	8.0	6.35	4.8	4.8	1000
HTS-330	6.4	4.8	4.8	6.4	1000
HTS-475	25.4	4.75	4.75	6.35	1000
HTS-490	15.24	4.75	4.75	6.35	1000
HTS-491	19.1	6.0	4.8	6.4	1000
HTS-498	22.2	4.75	4.75	6.35	1000

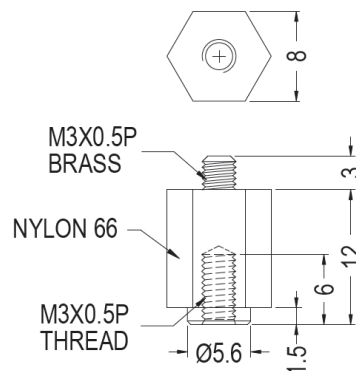
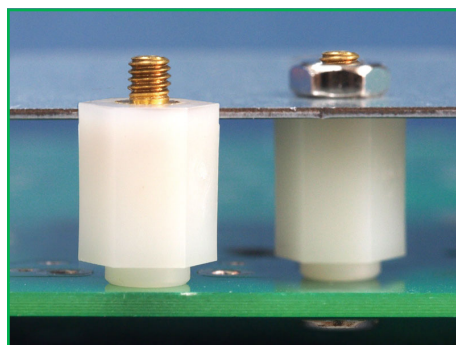

PART NO	PACKAGE
HTS-360	1000



塑料铜柱 FEMALE-FEMALE STANDOFF 尼龙柱 六角隔离柱 塑胶铜柱

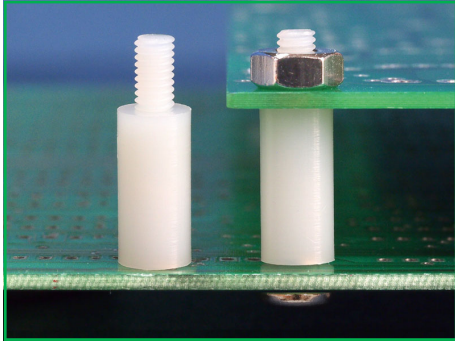

- ◆ MATERIAL : NYLON 66(UL)
- ◆ FLAME CLASS : 94V-2,94V-0
- ◆ COLOR : BLACK/NATURAL
- ◆ UNIT: mm

用途：塑料铜柱作为电路板与机板间之固定，一端配合螺丝，另一端配合螺帽使用。

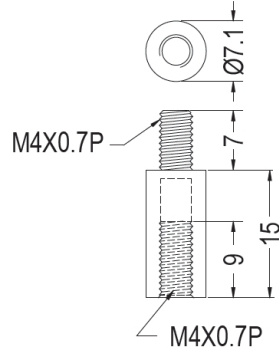

PART NO	PACKAGE
HTS-279	1000

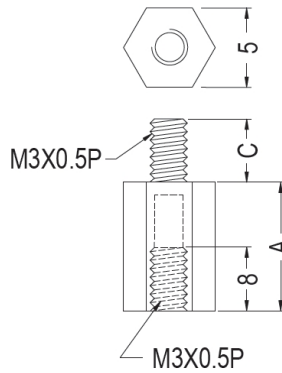
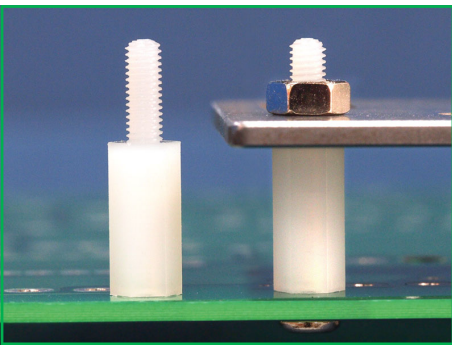

PART NO	A	C	PACKAGE
HTS-280	10.0	8.0	1000
HTS-281	12.0	8.0	1000
HTS-282	15.0	8.0	1000
HTS-283	18.0	8.0	1000
HTS-284	20.0	8.0	1000
HTS-285	25.0	8.0	1000
HTS-447	10.0	5.0	1000
HTS-463	13.0	8.0	1000

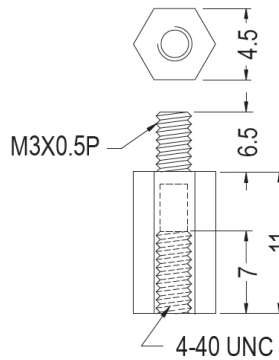
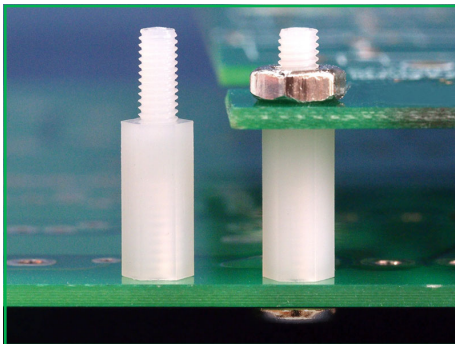

PART NO	PACKAGE
HTS-289	1000

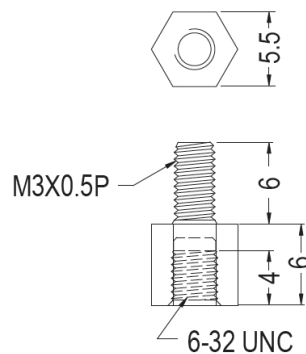

PART NO	PACKAGE
HTS-290	1000



# 塑料铜柱 FEMALE-FEMALE STANDOFF 尼龙柱 六角隔离柱 塑胶铜柱

PC板塑料铜柱

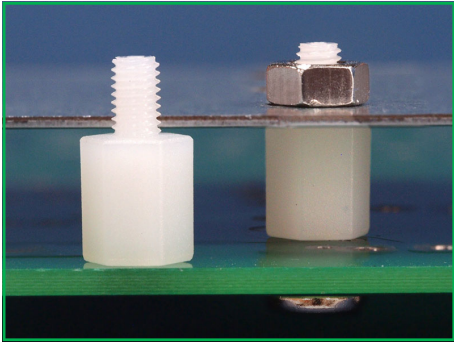

- ◆ MATERIAL : NYLON 66(UL)
- ◆ FLAME CLASS : 94V-2,94V-0
- ◆ COLOR : BLACK/NATURAL
- ◆ UNIT: mm

用途：塑料铜柱作为电路板与机板间之固定，一端配合螺丝，另一端配合螺帽使用。

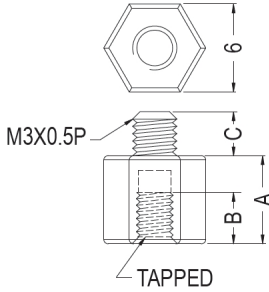

PART NO	A	B	C	D	PACKAGE
HTS-291	7.5	6.25	4.76	M3X0.50	1000
HTS-337	6.0	3.5	3.0	M2.5X0.45P	1000

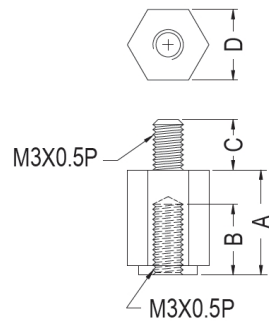
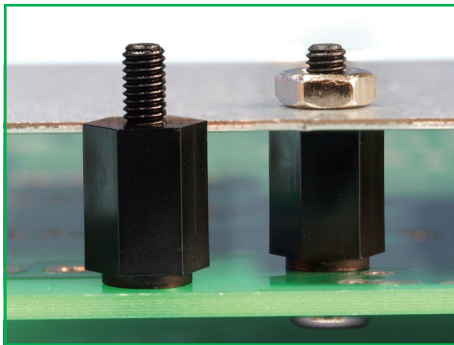

PART NO	A	B	C	D	PACKAGE
HTS-402	10.4	7.0	5.0	7.0	1000
HTS-455	6.0	4.0	8.0	6.0	1000
HTS-465	10.0	8.0	8.0	6.0	1000
HTS-466	12.0	10.0	8.0	6.0	1000
HTS-467	18.0	10.0	8.0	6.0	1000
HTS-513	11.0	9.0	8.0	6.0	1000

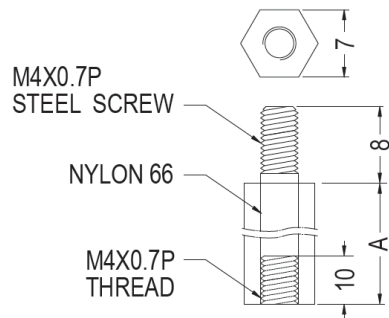
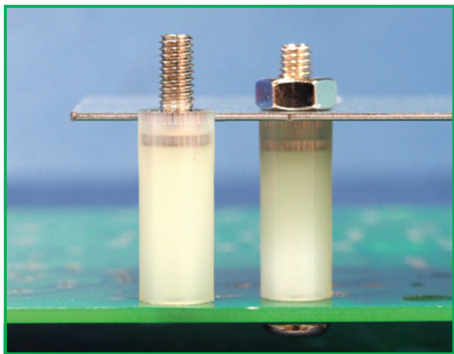

PART NO	A	PACKAGE
HTS-338	20.0	1000
HTS-339	57.0	1000

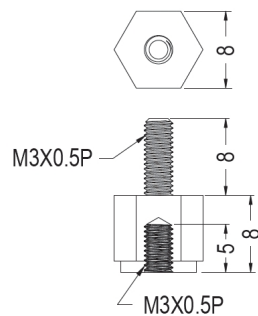
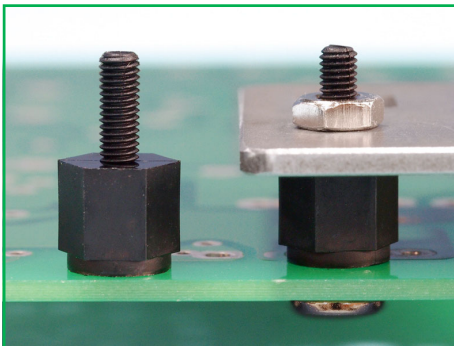

PART NO	PACKAGE
HTS-362	1000

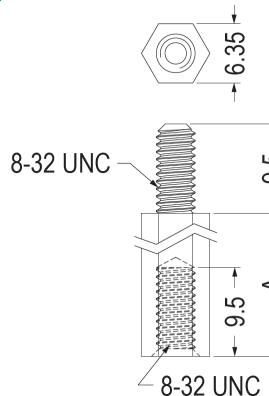
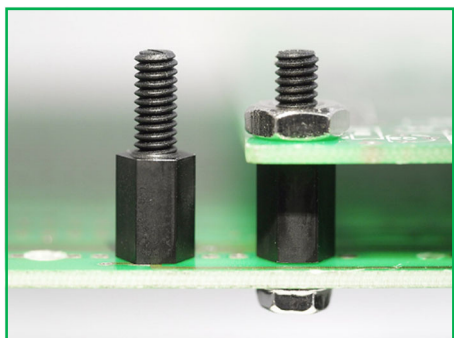

PART NO	A	PACKAGE
HTS-505	12.7	1000
HTS-506	19.1	1000
HTS-507	22.2	1000

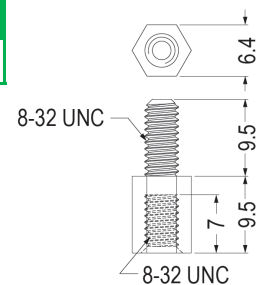

- Material: Nylon 46 (UL)
- Flame Class: 94V-2
- Color: Black

PART NO	PACKAGE
HTS-508	1000

# 塑料铜柱 FEMALE-FEMALE STANDOFF 尼龙柱 六角隔离柱 塑胶铜柱

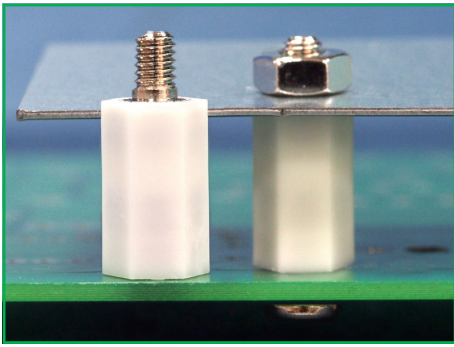

- ◆ MATERIAL : NYLON 66(UL)
- ◆ FLAME CLASS : 94V-2,94V-0
- ◆ COLOR : BLACK/NATURAL
- ◆ UNIT: mm

用途：塑料铜柱作为电路板与机板间之固定，一端配合螺丝，另一端配合螺帽使用。

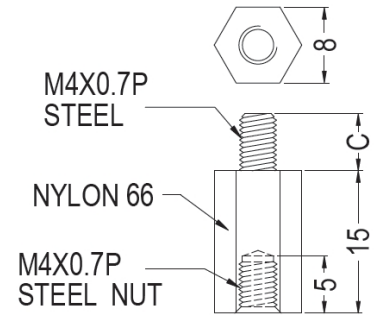
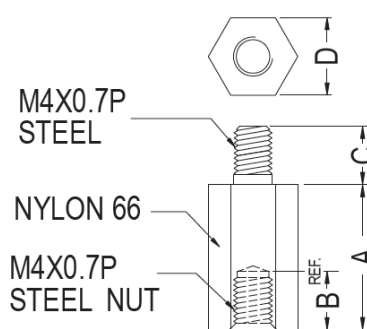

PART NO	A	B	C	D	PACKAGE
HTS-340	15.0	5.0	6.0	8.0	1000
HTS-470	50.0	6.0	8.0	9.0	1000

PART NO	A	PACKAGE
HTS-343	6.0	1000
HTS-344	8.0	1000

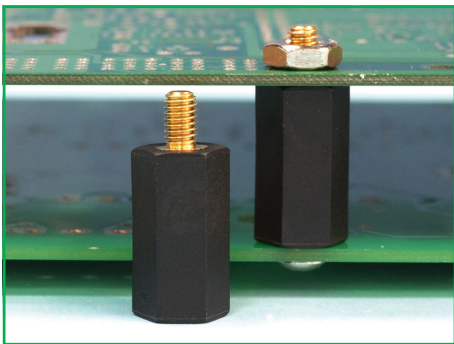

- ◆ MATERIAL : NYLON 66(UL)
- ◆ FLAME CLASS : 94V-2,94V-0
- ◆ COLOR : BLACK/NATURAL
- ◆ UNIT: mm

用途：塑料铜柱作为电路板与电路板间之固定，不占空间。

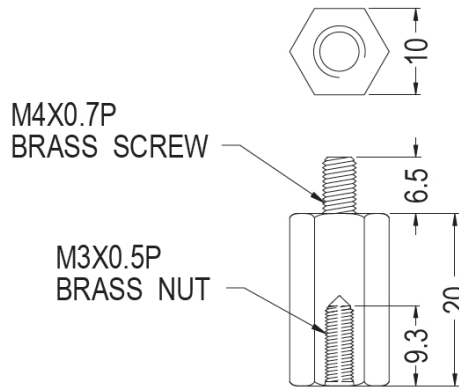

PART NO	PACKAGE
HTS-354	1000

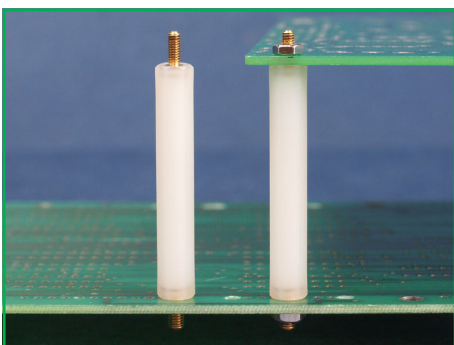

- ◆ MATERIAL : NYLON 66(UL)
- ◆ FLAME CLASS : 94V-2,94V-0
- ◆ COLOR : BLACK/NATURAL
- ◆ UNIT: mm

用途：塑料铜柱作为电路板与机板间之固定，两端配合攻牙或螺母使用。

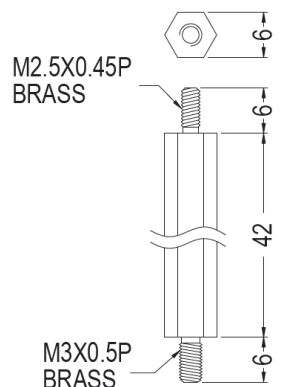

PART NO	PACKAGE
HTS-342	1000

塑料铜柱 FEMALE-FEMALE STANDOFF 尼龙柱 六角隔离柱 塑胶铜柱

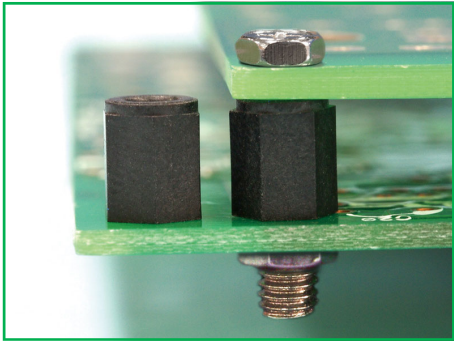

- ◆ MATERIAL : NYLON 66(UL)
- ◆ FLAME CLASS : 94V-2,94V-0
- ◆ COLOR : BLACK/NATURAL
- ◆ UNIT: mm

用途：塑料铜柱作为电路板与机板间之固定，六角型不滑动。

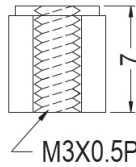

PART NO	PACKAGE
HTS-442	1000

PC板塑料铜柱

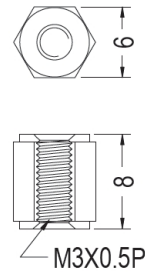
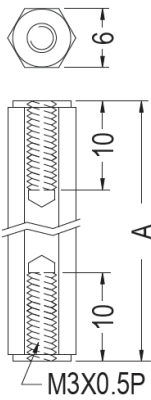
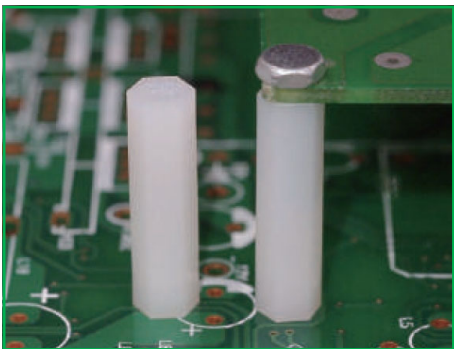

- Material: Nylon 6 (UL)
- Flame Class: 94HB
- Color: Black

PART NO	A	PACKAGE
HTS-348	20.0	1000
HTS-370	30.0	1000

PART NO	PACKAGE
HTS-476	1000

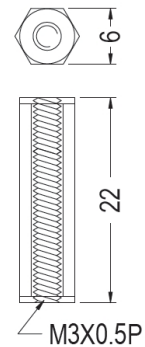
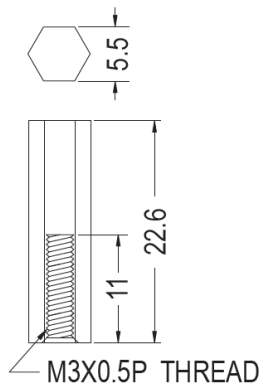

- Material: Nylon 6 (UL)
- Flame Class: 94HB
- Color: Black

PART NO	PACKAGE
HTS-473	1000

PART NO	PACKAGE
HTS-477	1000

# 塑料铜柱 FEMALE-FEMALE STANDOFF 尼龙柱 六角隔离柱 塑胶铜柱

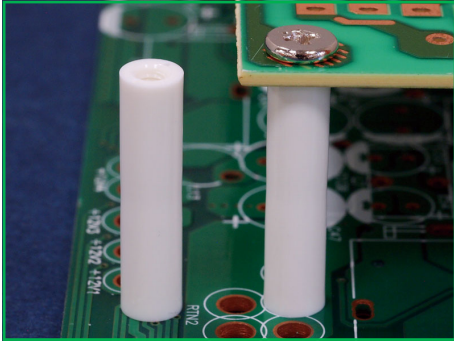

- ◆ MATERIAL : NYLON 66(UL)
- ◆ FLAME CLASS : 94V-2,94V-0
- ◆ COLOR : BLACK/NATURAL/WHITE
- ◆ UNIT: mm

用途：塑料铜柱作为电路板与机板间之固定。

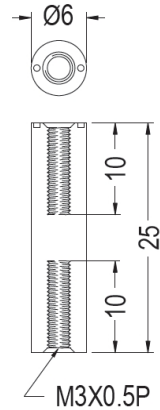
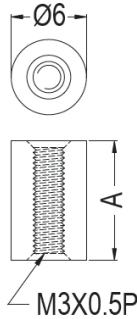

PART NO	A	PACKAGE
HTS-444	9.0	1000
HTS-445	9.5	1000

PART NO	A	PACKAGE
HTS-349	25.0	1000

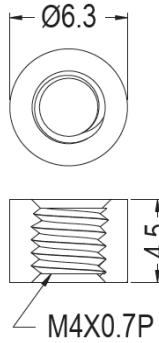
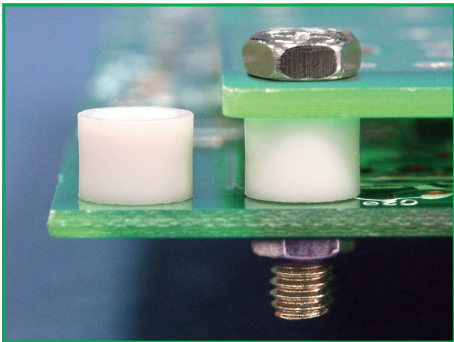

PART NO	PACKAGE
HTS-446	1000

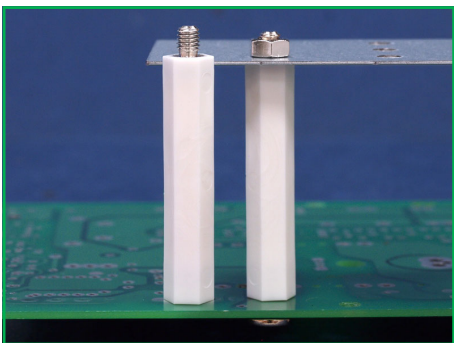

- ◆ MATERIAL : NYLON 66(UL)
- ◆ FLAME CLASS : 94V-2,94V-0
- ◆ COLOR : BLACK/NATURAL
- ◆ UNIT: mm

用途：塑料铜柱作为电路板与机板间之固定，一端配合螺丝，另一端配合螺帽使用。

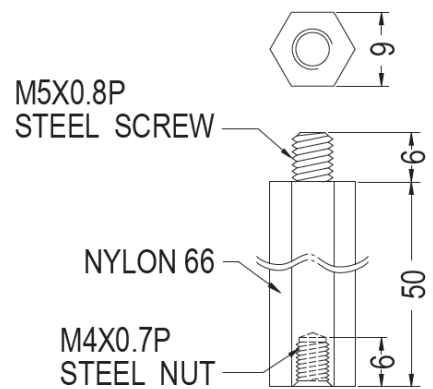
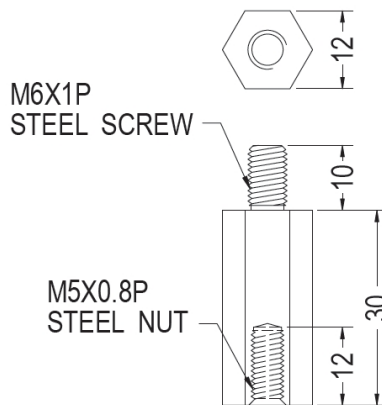

PART NO	PACKAGE
HTS-353	1000

PART NO	PACKAGE
HTS-359	250

# 塑料铜柱 FEMALE-FEMALE STANDOFF 尼龙柱 六角隔离柱 塑胶铜柱

PC板塑料铜柱

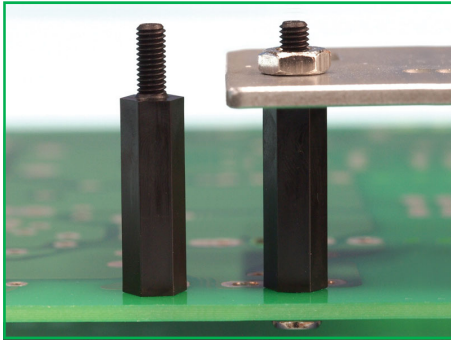

- ◆ MATERIAL : POM
- ◆ COLOR : BLACK
- ◆ UNIT: mm

用途：塑料铜柱作为电路板与机板间之固定，六角型不滑动。

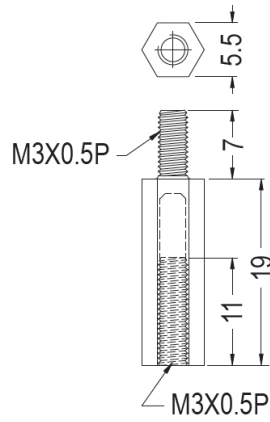

PART NO	PACKAGE
HTS-361	1000

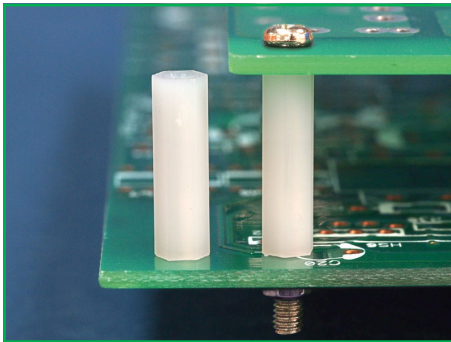

- ◆ MATERIAL : NYLON 66(UL)
- ◆ FLAME CLASS : 94V-2,94V-0
- ◆ COLOR : BLACK/NATURAL
- ◆ UNIT: mm

用途：塑料铜柱作为电路板与机板间之固定，六角型不滑动。

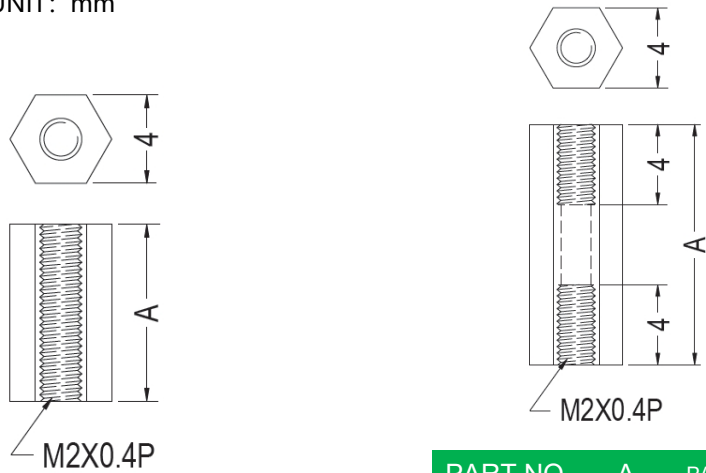

PART NO	A	PACKAGE
HTS-407	4.0	1000
HTS-408	5.0	1000
HTS-409	6.0	1000
HTS-410	7.0	1000
HTS-411	8.0	1000
HTS-412	9.0	1000
HTS-413	10.0	1000
HTS-414	11.0	1000
HTS-415	12.0	1000
HTS-416	12.7	1000
HTS-434	4.5	1000

PART NO	A	PACKAGE
HTS-417	13.0	1000
HTS-418	14.0	1000
HTS-419	15.0	1000
HTS-420	16.0	1000
HTS-421	17.0	1000
HTS-422	18.0	1000
HTS-423	19.0	1000
HTS-424	20.0	1000
HTS-425	21.0	1000
HTS-426	22.0	1000
HTS-427	23.0	1000
HTS-428	24.0	1000
HTS-429	25.0	1000

# 塑料铜柱 FEMALE-FEMALE STANDOFF 尼龙柱 六角隔离柱 塑胶铜柱

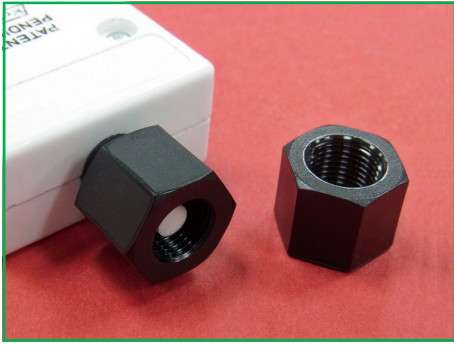

- ◆ MATERIAL : NYLON 66(UL)
- ◆ FLAME CLASS : 94V-2,94V-0
- ◆ COLOR : BLACK/NATURAL
- ◆ UNIT: mm

用途：塑料铜柱作为断路器保护，避免误触。

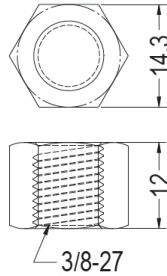

PART NO	PACKAGE
HTS-371	1000

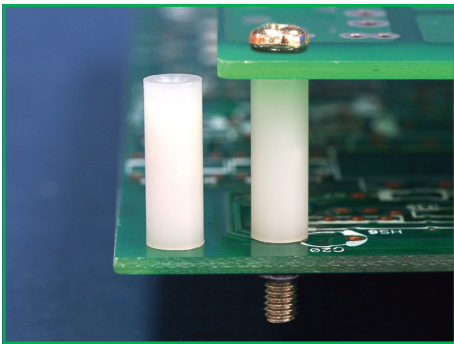

- ◆ MATERIAL : NYLON 66(UL)
- ◆ FLAME CLASS : 94V-2,94V-0
- ◆ COLOR : BLACK/NATURAL
- ◆ UNIT: mm

用途：塑料铜柱作为电路板与机板间之固定。

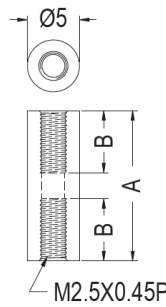

PART NO	A	B	PACKAGE
HTS-406	14.5	6.0	1000
HTS-440	20.0	9.0	1000

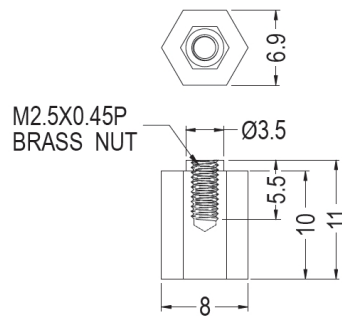
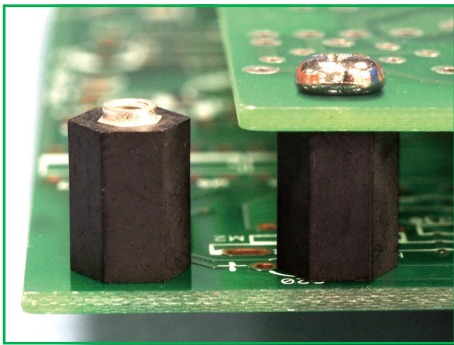

PART NO	PACKAGE
HTS-448	1000

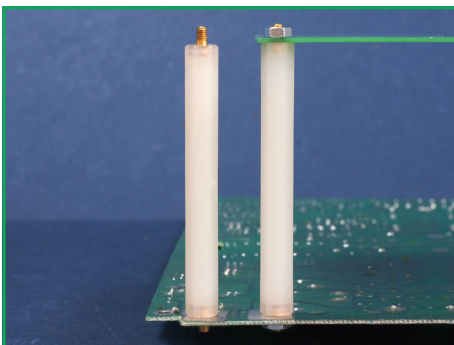

- ◆ MATERIAL : NYLON 6
- ◆ COLOR : NATURAL
- ◆ UNIT: mm

用途：塑料铜柱作为电路板与机板间之固定，两端配合攻牙或螺母使用。

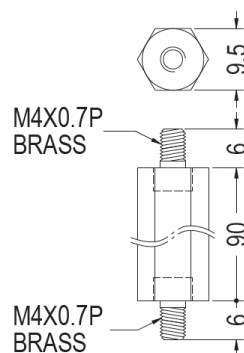

PART NO	PACKAGE
HTS-449	500

# 塑料铜柱 FEMALE-FEMALE STANDOFF 尼龙柱 六角隔离柱 塑胶铜柱

PC板塑料铜柱

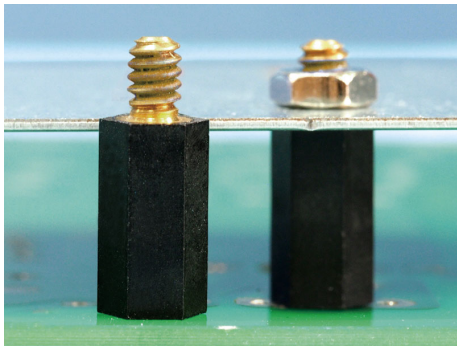

- ◆ MATERIAL : NYLON 66(UL)
- ◆ FLAME CLASS : 94V-2,94V-0
- ◆ COLOR : BLACK/NATURAL
- ◆ UNIT: mm

用途：塑料铜柱作为电路板与机板间之固定，一端配合螺丝，另一端配合螺帽使用。

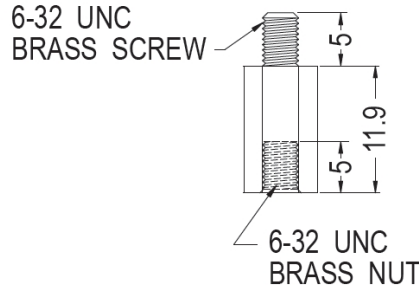

PART NO	PACKAGE
HTS-456	1000

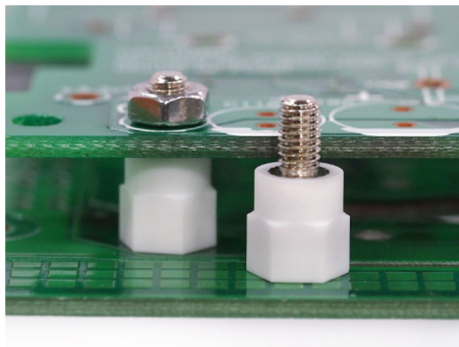

- ◆ MATERIAL : NYLON 6(UL)
- ◆ FLAME CLASS : 94V-0
- ◆ COLOR : NATURAL
- ◆ UNIT: mm

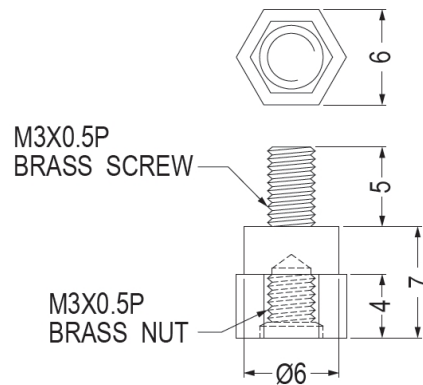

PART NO	PACKAGE
HTS-495	1000

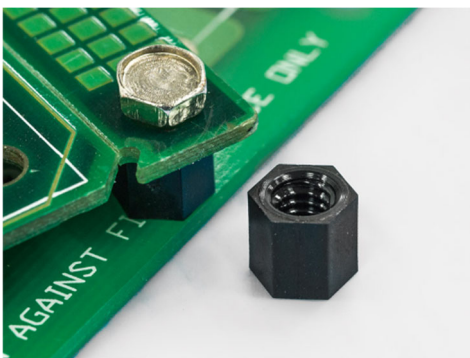

- ◆ MATERIAL : NYLON 66(UL)
- ◆ FLAME CLASS : 94V-2,94V-0
- ◆ COLOR : BLACK/NATURAL
- ◆ UNIT: mm

用途：塑料铜柱作为电路板与机板间之固定。

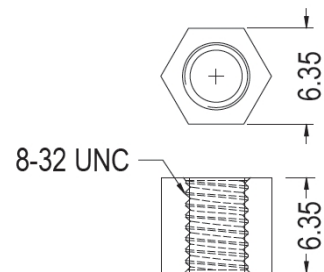
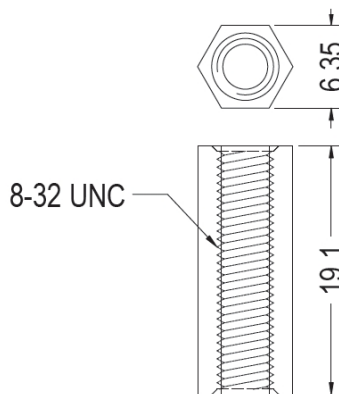

- Material: Nylon 46 (UL)
- Flame Class: 94V-2
- Color: Black

PART NO	PACKAGE
HTS-494	1000

PART NO	PACKAGE
HTS-474	1000

# 铜柱 MALE-FEMALE STANDOFF 六角隔离柱

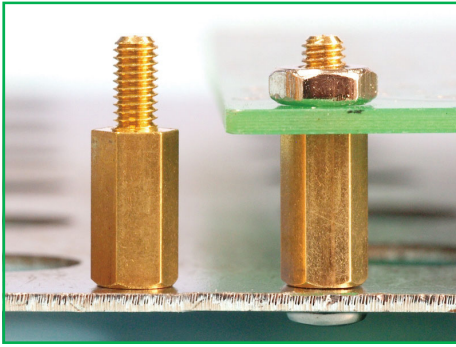

- ◆ MATERIAL : BRASS
- ◆ UNIT: mm

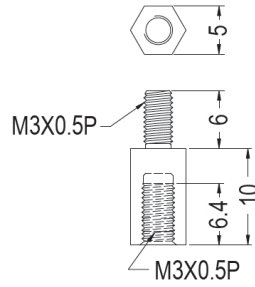

用途：塑料铜柱作为电路板与机板间之固定，一端配合螺丝，另一端配合螺帽使用。

PART NO	PACKAGE
TZC-001	1000

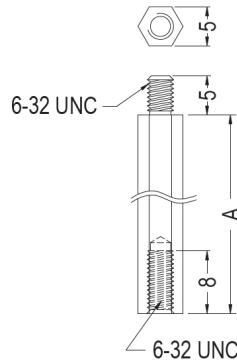
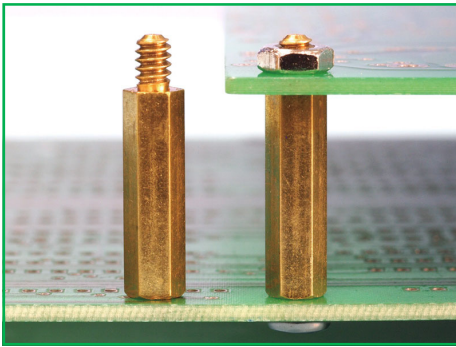

PART NO	A	PACKAGE
TZC-002	19.05	1000
TZC-003	25.4	1000

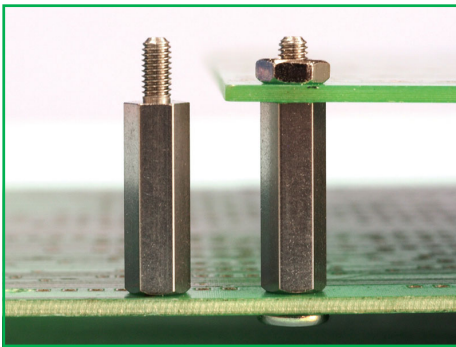

- ◆ MATERIAL : STEEL/SUS
- ◆ UNIT: mm

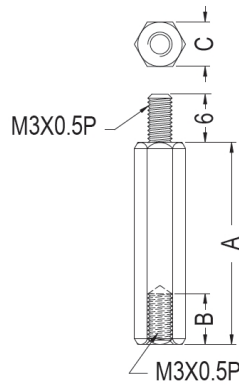

PART NO	A	B	C	PACKAGE
TZC-004	25.0	6.0	5.0	500
TZC-005	30.0	6.0	5.0	500
TZC-006	18.0	8.0	5.5	500
TZC-007	54.9	8.0	5.5	500

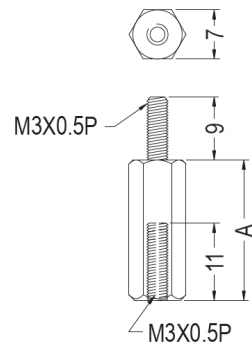
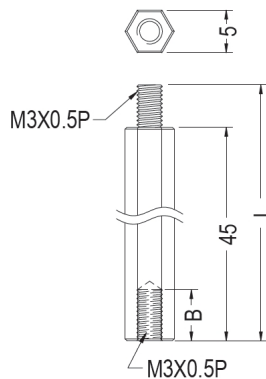
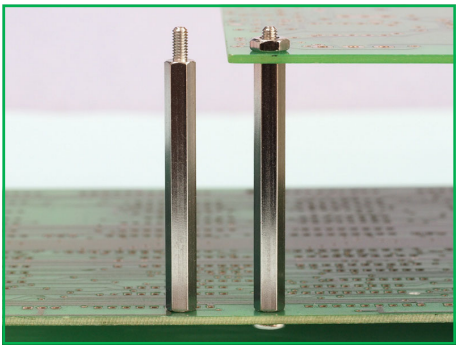

PART NO	B	L	PACKAGE
TZC-008	5.5	51.5	500
TZC-009	6.0	52.0	500

PART NO	A	PACKAGE
TZC-010	20.0	500
TZC-011	40.0	500



# 塑料铜柱 FEMALE-FEMALE STANDOFF 尼龙柱 六角隔离柱 塑胶铜柱

PC板铜柱

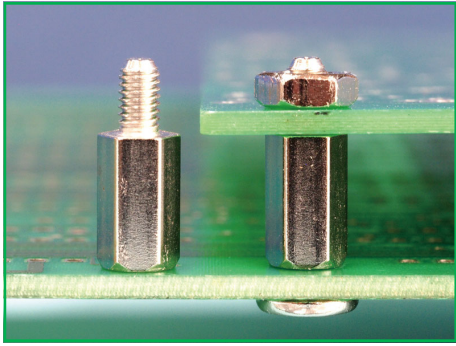

- ◆ MATERIAL : STEEL
- ◆ UNIT: mm

用途：塑料铜柱电路板与机板间之固定，一端配合螺丝，另一端配合螺帽使用。

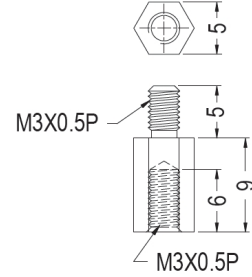
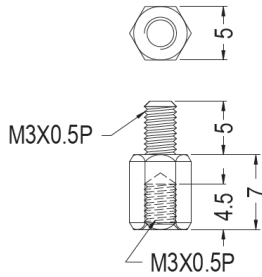

PART NO	PACKAGE
TZC-012	1000

PART NO	PACKAGE
TZC-013	1000

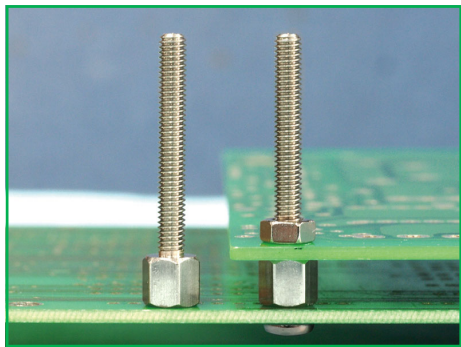

- ◆ MATERIAL : SUS
- ◆ UNIT: mm

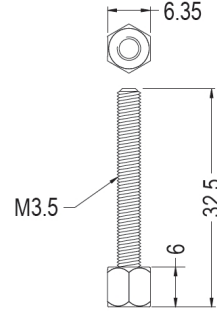
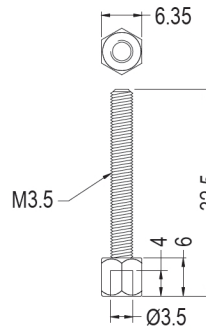

PART NO	PACKAGE
TZC-014	1000

PART NO	PACKAGE
TZC-015	1000

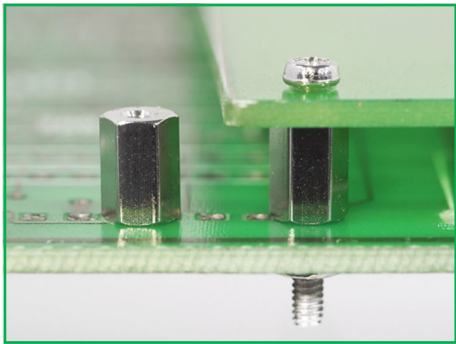

- ◆ MATERIAL : BRASS
- ◆ FINISH: NICKEL PLATED
- ◆ UNIT: mm

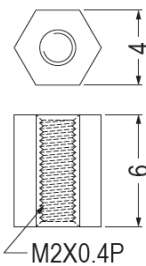

PART NO	PACKAGE
TZC-016	1000

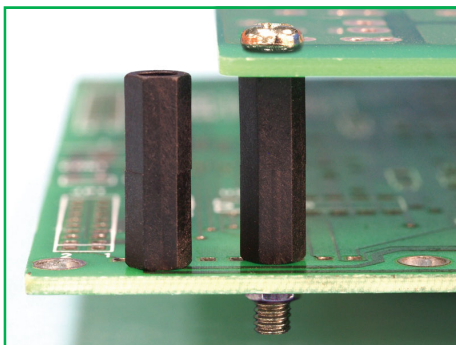

- ◆ MATERIAL : NYLON 66(UL)
- ◆ FLAME CLASS : 94HB
- ◆ COLOR : BLACK/NATURAL
- ◆ UNIT: mm

用途：塑料铜柱，做为电路板与机板隔离之固定，六角型不滑动。

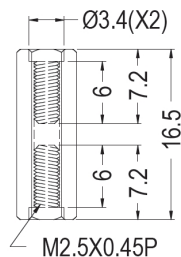

PART NO	PACKAGE
HTS-496	1000

# 导光板间隔柱 PILLAR SUPPORT 导光板隔离柱

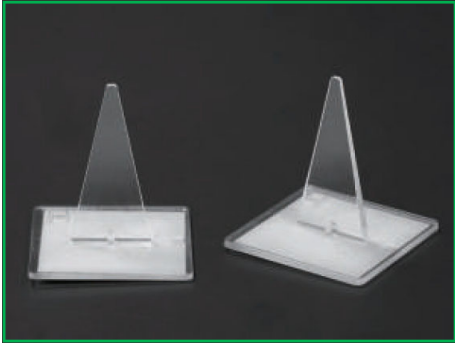

PART NO	PACKAGE
DGBG-1	1000

- ◆ MATERIAL : PC(UL)
- ◆ FLAME CLASS : 94V-0
- ◆ COLOR : TRANSPARENT
- ◆ UNIT: mm

用途：导光板隔离柱用于支撑液晶面板，高导光，高反射，高透光。

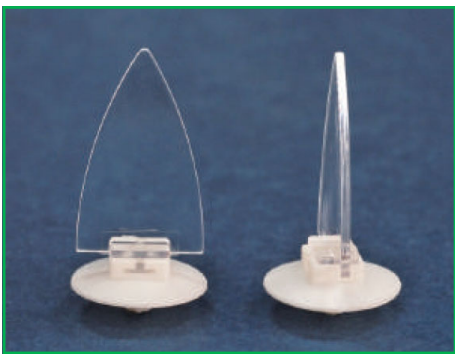
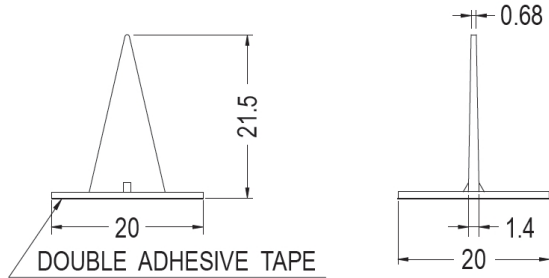

PART NO	PACKAGE
DGBG-2	1000

- ◆ MATERIAL 1 : PC(UL)
- ◆ MATERIAL 2 : NYLON 66(UL)
- ◆ FLAME CLASS : 94V-0/94V-2
- ◆ COLOR 1: TRANSPARENT
- ◆ COLOR 2: NATURAL/WHITE
- ◆ UNIT: mm

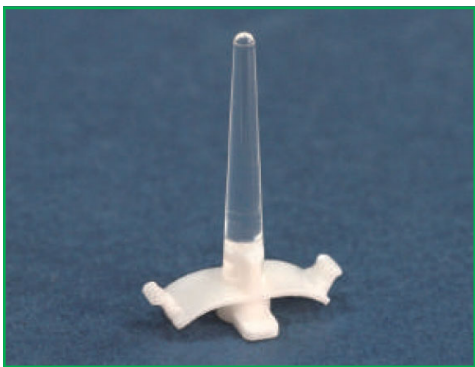
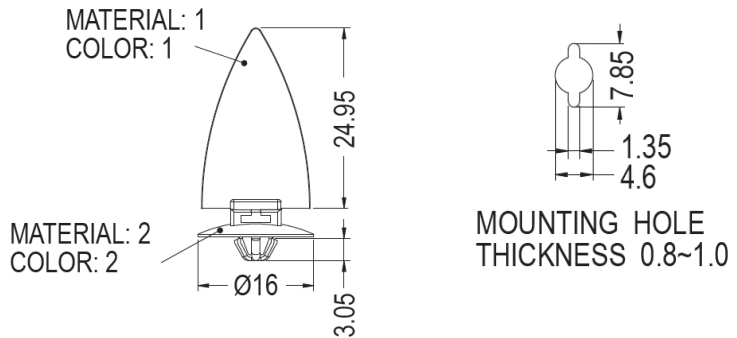

PART NO	PACKAGE
DGBG-3	1000

- ◆ MATERIAL : PC(UL) / 94V-0
- ◆ COLOR : TRANSPARENT
- ◆ BASE MATERIAL: NYLON 66(UL) / 94V-0
- ◆ BASE COLOR : NATURAL
- ◆ UNIT: mm

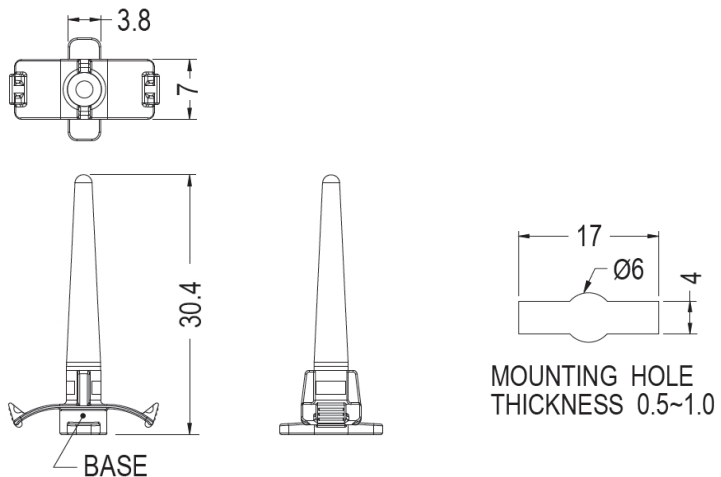

导光板间隔柱

# 导光板间隔柱 PILLAR SUPPORT 导光板隔离柱

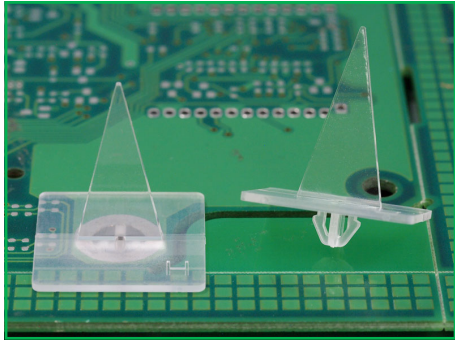

- ◆ MATERIAL : PC(UL)
- ◆ FLAME CLASS : 94V-0
- ◆ COLOR : TRANSPARENT
- ◆ UNIT: mm

用途：导光板隔离柱用于支撑液晶面板，高导光，高反射，高透光。

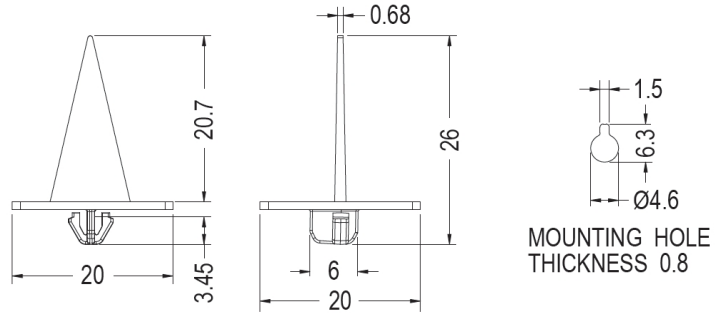

PART NO	PACKAGE
DGBG-4	1000

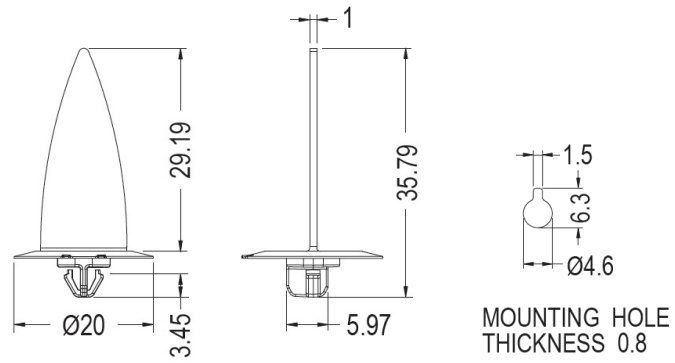
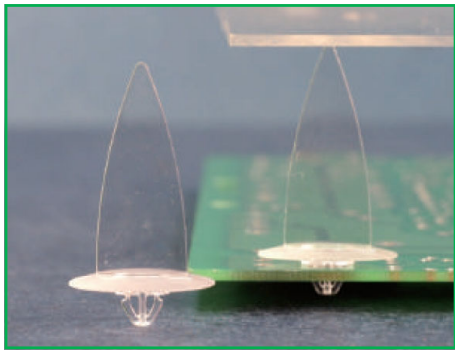

PART NO	PACKAGE
DGBG-5	1000

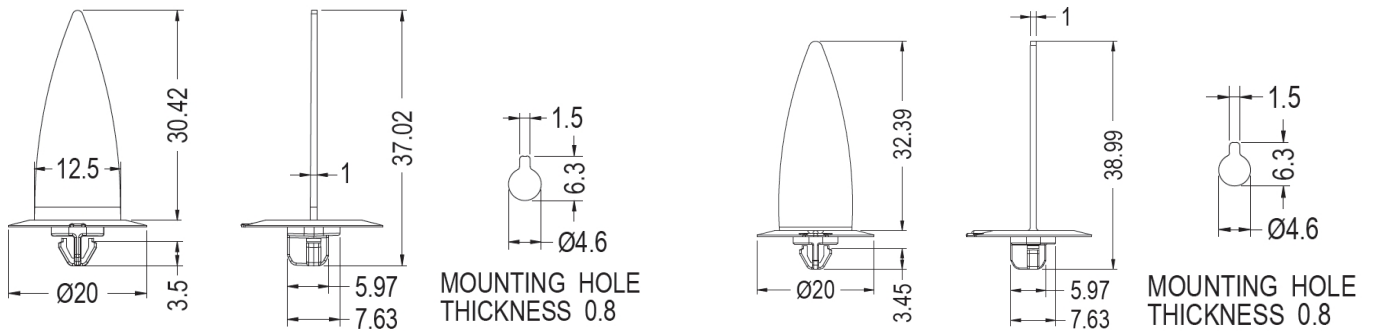

PART NO	PACKAGE
DGBG-6	1000

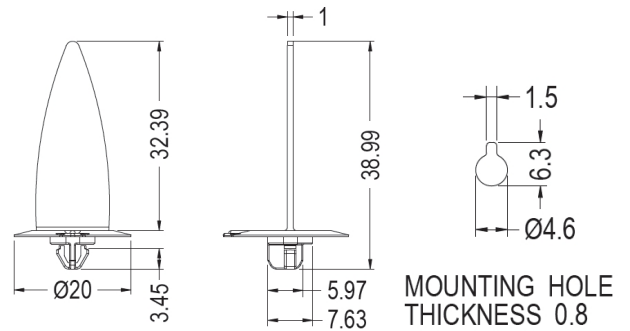

PART NO	PACKAGE
DGBG-19	1000

# 导光板间隔柱 PILLAR SUPPORT 导光板隔离柱

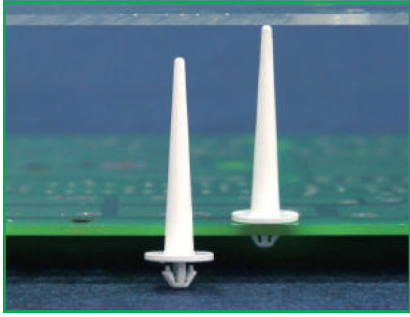

- ◆ MATERIAL : PC(UL)
- ◆ FLAME CLASS : 94V-0/94V-2
- ◆ COLOR : TRANSPARENT/NATURAL
- ◆ UNIT: mm

用途：导光板隔离柱用于支撑液晶面板，高导光，高反射，高透光。

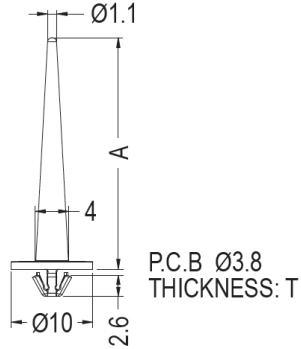

PART NO	A	T	PACKAGE
DGBG-7	28.5	0.5~0.65	1000
DGBG-8	29.5	0.5~0.65	1000
DGBG-9	29.5	0.6~0.8	1000

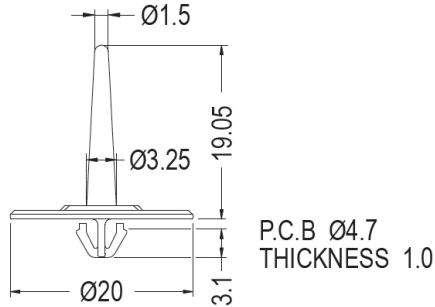
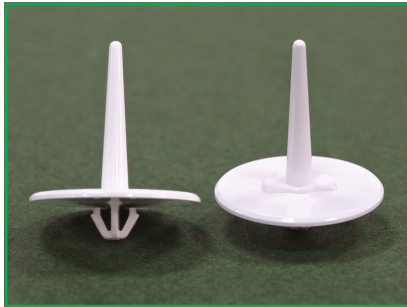

PART NO	PACKAGE
DGBG-10	1000

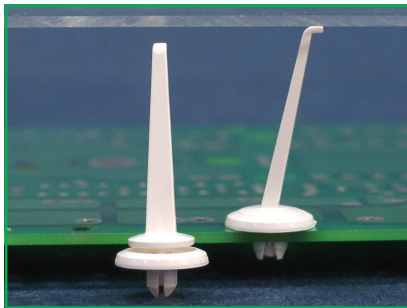

- ◆ MATERIAL : PC(UL)
- ◆ FLAME CLASS : 94V-0
- ◆ COLOR : NATURAL
- ◆ UNIT: mm

用途：导光板隔离柱用于支撑液晶面板，高导光，高反射，高透光。

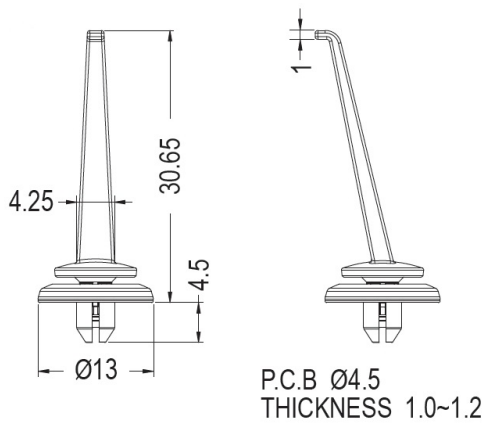

PART NO	PACKAGE
DGBG-11	500

导光板间隔柱

# 导光板间隔柱 PILLAR SUPPORT 导光板隔离柱

导光板间隔柱

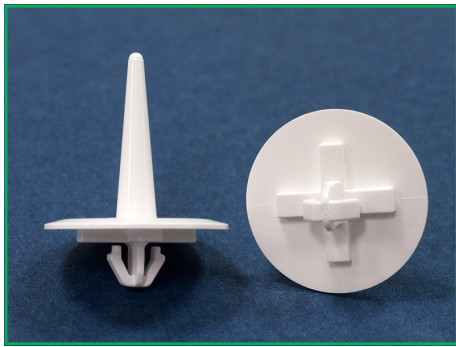

- ◆ MATERIAL : PC(UL)
- ◆ FLAME CLASS : 94V-0
- ◆ COLOR : NATURAL
- ◆ UNIT: mm

用途： 导光板隔离柱用于支撑液晶面板，高导光，高反射，高透光。

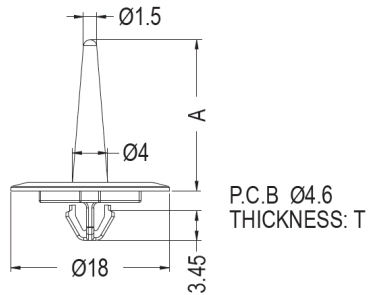

PART NO	A	T	PACKAGE
DGBG-12	17.16	0.6~0.8	1000
DGBG-13	31.42	0.8	500
DGBG-39	18.0	0.8	1000

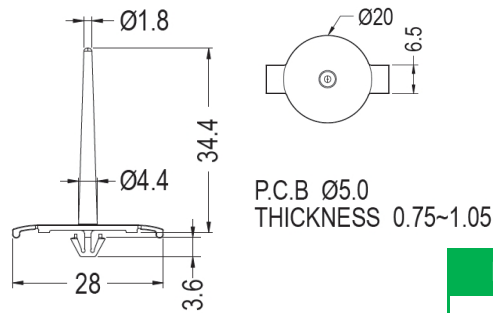
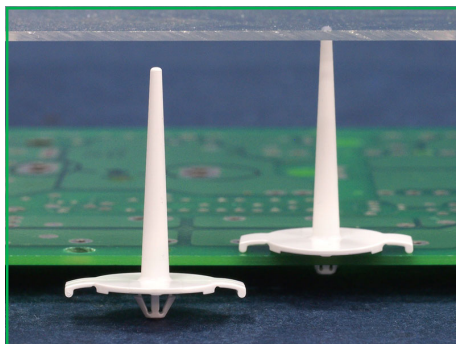

PART NO	PACKAGE
DGBG-14	1000

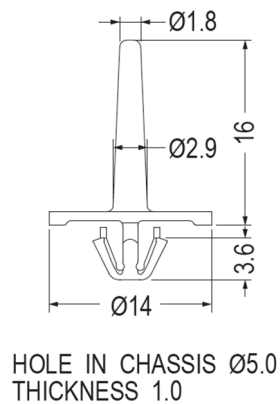

PART NO	PACKAGE
DGBG-48	1000

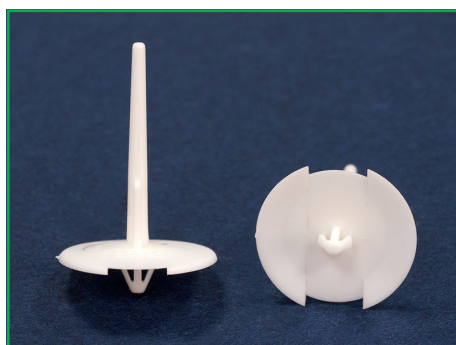

- ◆ MATERIAL : NYLON 66(UL)
- ◆ FLAME CLASS : 94V-0
- ◆ COLOR : WHITE
- ◆ UNIT: mm

用途： 导光板隔离柱用于支撑液晶面板，高导光，高反射，高透光。

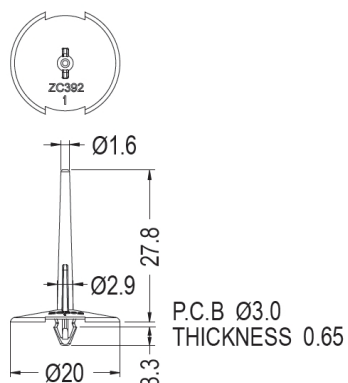

PART NO	PACKAGE
DGBG-15	1000

# 导光板间隔柱 PILLAR SUPPORT 导光板隔离柱



- ◆ MATERIAL : PC(UL)
- ◆ FLAME CLASS : 94V-0/94V-2
- ◆ COLOR : TRANSPARENT/NATURAL
- ◆ UNIT: mm

用途：导光板隔离柱用于支撑液晶面板，高导光，高反射，高透光。

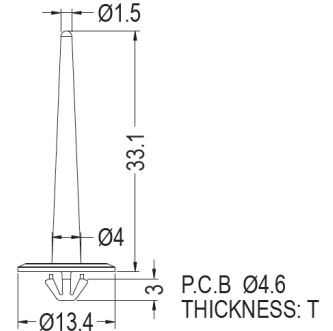
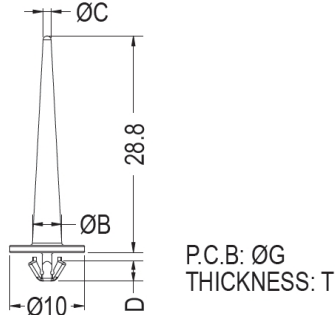

PART NO	B	C	D	G	T	PACKAGE
DGBG-16	3.9	1.06	2.65	3.8	1.0	1000
DGBG-17	4.3	1.5	2.65	3.8	1.25	1000
DGBG-18	3.9	1.06	2.5	3.5	0.8	1000

PART NO	T	PACKAGE
DGBG-20	0.5~0.8	500
DGBG-21	0.6	500

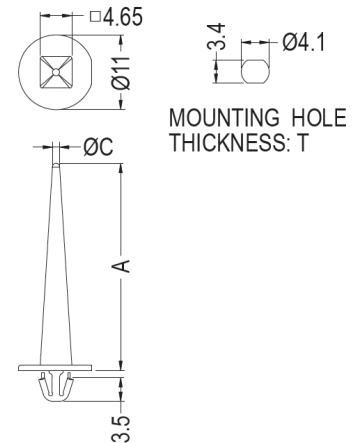
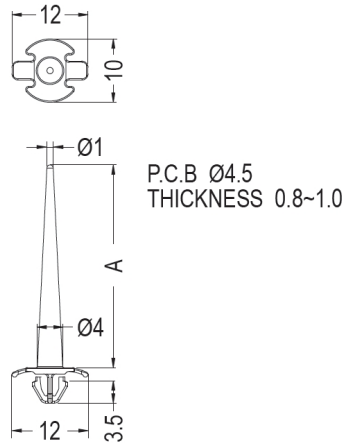
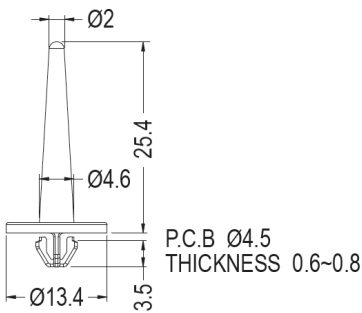

PART NO	PACKAGE
DGBG-22	1000

PART NO	A	PACKAGE
DGBG-23	32.0	1000
DGBG-24	28.0	1000

PART NO	A	C	T	PACKAGE
DGBG-25	30.5	0.8	1.0	1000
DGBG-26	35.8	1.05	1.05	1000

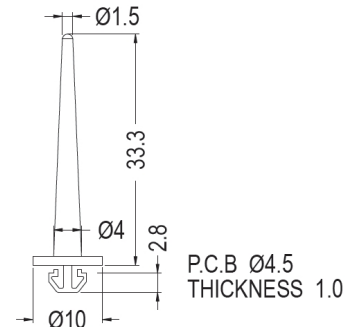
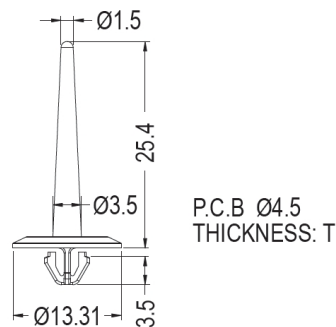
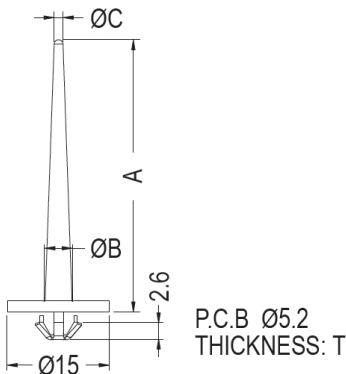

PART NO	A	B	C	T	PACKAGE
DGBG-27	23.5	4.5	1.6	0.8~1.0	500
DGBG-28	40.0	3.95	1.3	1.0~1.3	500

PART NO	T	PACKAGE
DGBG-29	0.6~0.8	500
DGBG-30	0.8~1.1	500

PART NO	PACKAGE
DGBG-35	1000

# 导光板间隔柱 PILLAR SUPPORT 导光板隔离柱

导光板间隔柱

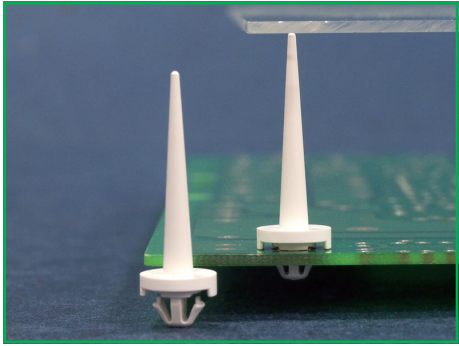

- ◆ MATERIAL : PC(UL)
- ◆ FLAME CLASS : 94V-0/90V-2
- ◆ COLOR : NATURAL/TRANSPARENT
- ◆ UNIT: mm

用途：导光板隔离柱用于支撑液晶面板，高导光，高反射，高透光。

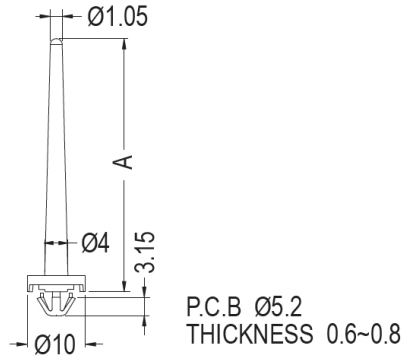

PART NO	A	PACKAGE
DGBG-31	42.6	500
DGBG-32	29.0	500

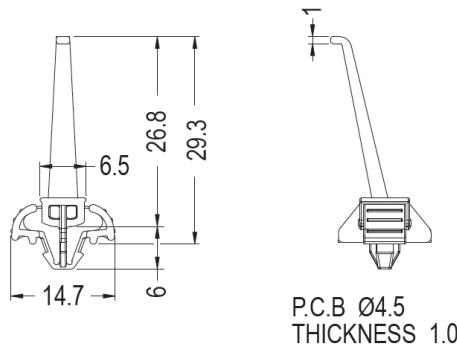
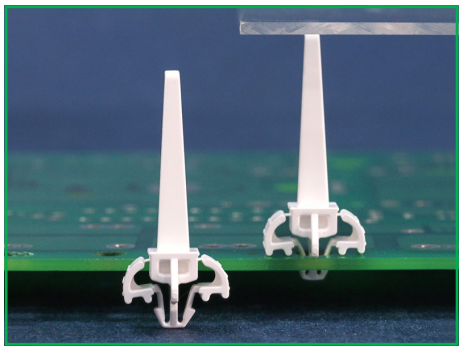

PART NO	PACKAGE
DGBG-33	1000

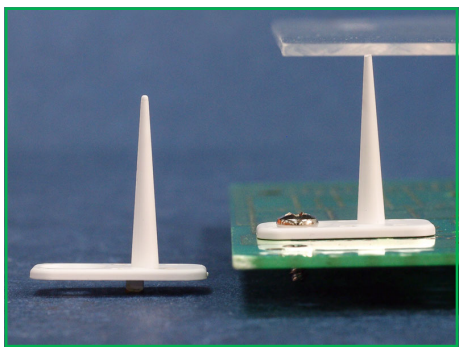

- ◆ MATERIAL : NYLON 66(UL)
- ◆ FLAME CLASS : 94V-0
- ◆ COLOR : WHITE
- ◆ UNIT: mm

用途：导光板隔离柱用于支撑液晶面板，高导光，高反射，高透光。

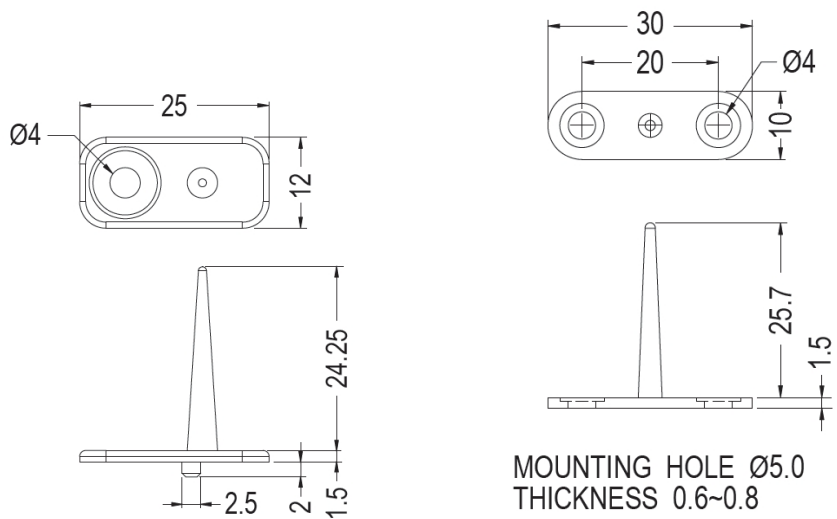

PART NO	PACKAGE
DGBG-34	1000

PART NO	PACKAGE
DGBG-36	1000

# 导光板间隔柱 PILLAR SUPPORT 导光板隔离柱

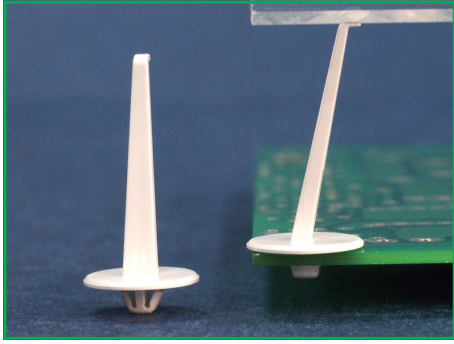

- ◆ MATERIAL : PC(UL)
- ◆ FLAME CLASS : 94V-0/94V-2
- ◆ COLOR : TRANSPARENT/NATURAL
- ◆ UNIT: mm

用途：导光板隔离柱用于支撑液晶面板，高导光，高反射，高透光。

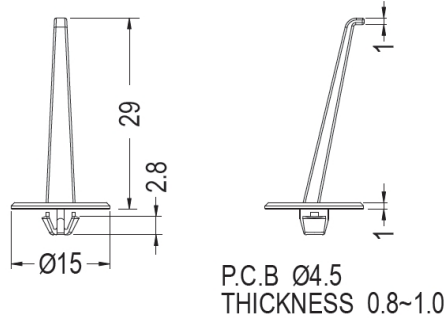

PART NO	PACKAGE
DGBG-37	1000

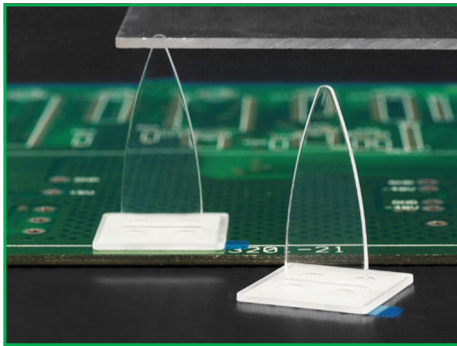

- ◆ MATERIAL : PC(UL)
- ◆ FLAME CLASS : 94V-0/94V-2
- ◆ COLOR : TRANSPARENT
- ◆ UNIT: mm

用途：导光板隔离柱用于支撑液晶面板，高导光，高反射，高透光。

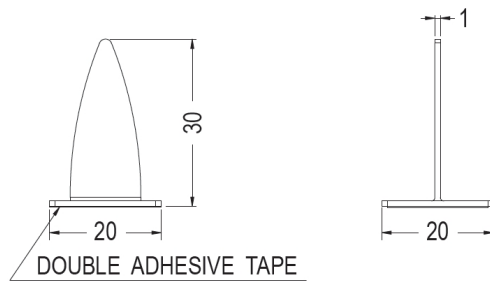

PART NO	PACKAGE
DGBG-38	1000

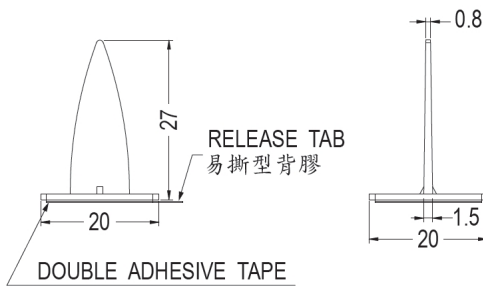
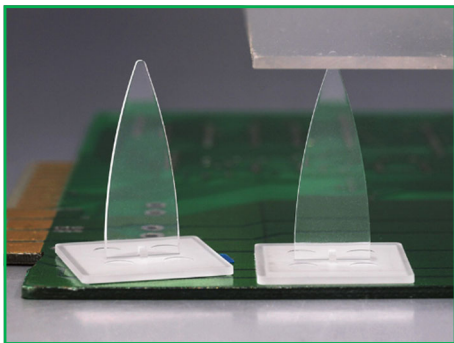

PART NO	PACKAGE
DGBG-44	1000

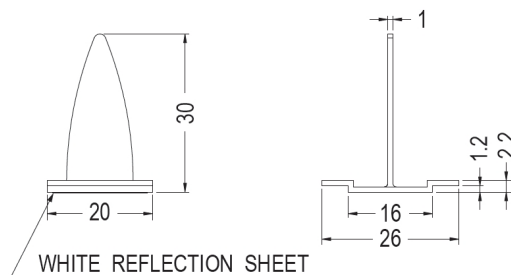
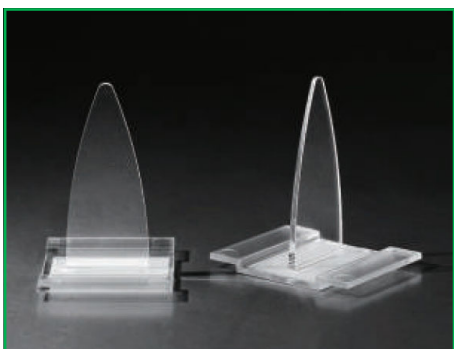

PART NO	PACKAGE
DGBG-40	1000



# 导光板间隔柱 PILLAR SUPPORT 导光板隔离柱

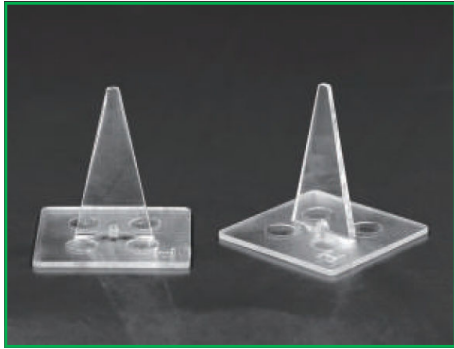

- ◆ MATERIAL : PC(UL)
- ◆ FLAME CLASS : 94V-0/90V-2
- ◆ COLOR : TRANSPARENT
- ◆ UNIT: mm

用途：导光板隔离柱用于支撑液晶面板，高导光，高反射，高透光。

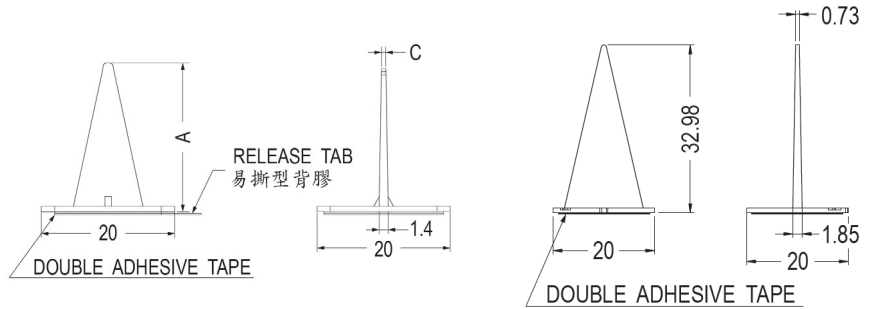

PART NO	A	C	PACKAGE
DGBG-41	20.7	0.71	1000
DGBG-47	22.3	0.68	1000

PART NO	PACKAGE
DGBG-42	1000

导光板间隔柱

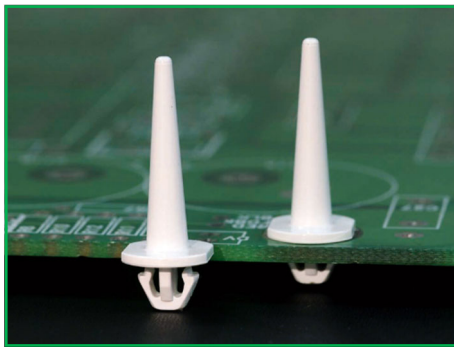

- ◆ MATERIAL : PC(UL)
- ◆ FLAME CLASS : 94V-0/90V-2
- ◆ COLOR : TRANSPARENT/NATURAL
- ◆ UNIT: mm

用途：导光板隔离柱用于支撑液晶面板，高导光，高反射，高透光。

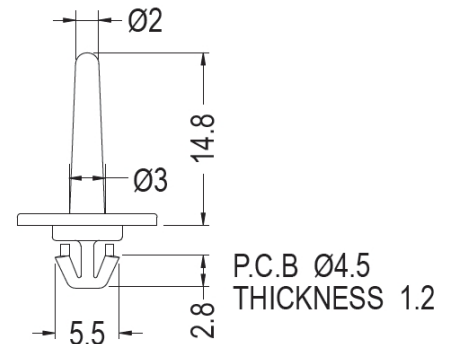
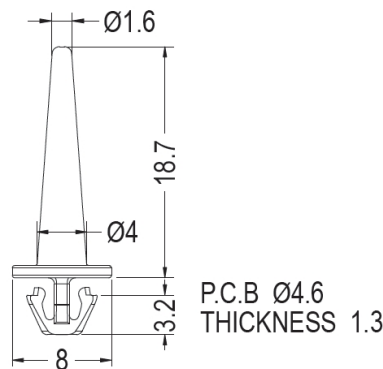

PART NO	PACKAGE
DGBG-43	1000

PART NO	PACKAGE
DGBG-45	1000

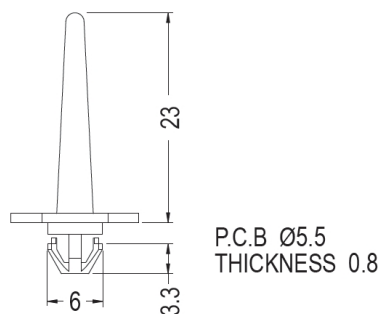

PART NO	PACKAGE
DGBG-46	1000

圆体间隔柱 ROUND SPACER 直通隔离柱 直通间隔柱 直通管柱 圆体隔离柱

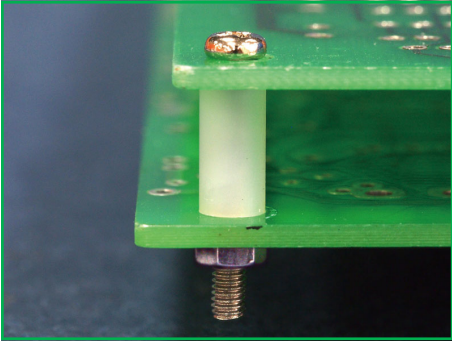

- ◆ MATERIAL : NYLON 66(UL)/PBT(UL) 用途：圆体间隔柱作为电路板之垫高
- ◆ FLAME CLASS : 94V-0/94V-2 用，尺寸齐全。
- ◆ COLOR : BLACK/NATURAL
- ◆ UNIT: mm

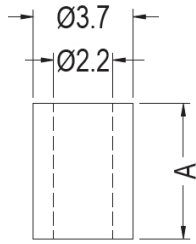

PART NO	A	PACKAGE
RS-1	1.8	2000
RS-2	2.0	2000
RS-3	2.5	2000
RS-4	3.0	2000
RS-5	3.2	2000
RS-6	4.0	2000
RS-7	4.3	2000
RS-8	5.0	2000
RS-9	6.0	2000
RS-10	7.0	2000

PART NO	A	PACKAGE
RS-11	8.0	2000
RS-12	9.0	2000
RS-13	9.5	2000
RS-14	10.0	2000
RS-15	11.0	2000
RS-16	12.0	2000
RS-17	13.0	2000
RS-18	14.0	2000
RS-19	15.0	2000
RS-20	16.0	2000
RS-257	5.0	2000

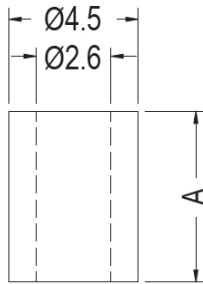

PART NO	A	PACKAGE
RS-21	2.0	2000
RS-22	3.0	2000
RS-23	4.0	2000
RS-24	5.0	2000
RS-25	6.0	2000
RS-26	7.0	2000
RS-27	8.0	2000

PART NO	A	PACKAGE
RS-28	9.0	2000
RS-29	10.0	2000
RS-31	11.0	2000
RS-32	12.0	2000
RS-30	13.0	2000
RS-33	14.0	2000
RS-34	15.0	2000
RS-35	16.0	2000

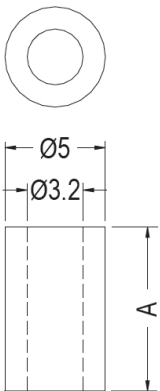

PART NO	A	PACKAGE
RS-131	25.0	1000
RS-132	26.0	1000
RS-133	27.0	1000
RS-134	28.0	1000
RS-135	29.0	1000
RS-136	30.0	1000
RS-137	35.0	1000
RS-138	3.15	2000
RS-374	7.0	2000
RS-227	4.5	2000
RS-303	5.05	2000
RS-306	6.0	2000
RS-329	6.35	2000

PART NO	A	PACKAGE
RS-116	14.0	1000
RS-117	15.0	1000
RS-118	15.5	1000
RS-119	16.0	1000
RS-120	16.5	1000
RS-121	19.8	1000
RS-122	17.0	1000
RS-123	17.5	1000
RS-124	18.0	1000
RS-125	19.0	1000
RS-126	20.0	1000
RS-127	21.0	1000
RS-128	22.0	1000
RS-129	23.0	1000
RS-130	24.0	1000

PART NO	A	PACKAGE
RS-40	2.0	2000
RS-80	7.5	
RS-95	2.5	2000
RS-96	3.0	2000
RS-97	3.3	2000
RS-98	4.0	2000
RS-99	4.2	2000
RS-107	8.0	2000
RS-108	9.0	2000
RS-109	9.5	2000
RS-110	10.0	2000
RS-111	10.5	2000
RS-112	11.0	2000
RS-113	12.0	2000
RS-114	13.0	1000
RS-115	13.6	1000

# 圆体间隔柱 ROUND SPACER 直通隔离柱 直通间隔柱 直通管柱 圆体隔离柱

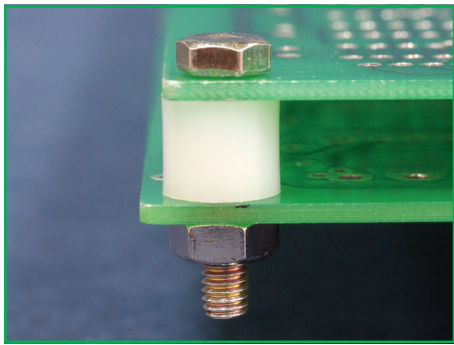

- ◆ MATERIAL : NYLON 66(UL)
- ◆ FLAME CLASS : 94V-0/90V-2
- ◆ COLOR : NATURAL/BLACK
- ◆ UNIT: mm

用途：圆体间隔柱作为电路板之垫高用，尺寸齐全。

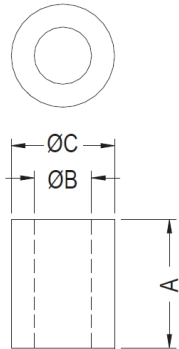

PART NO	A	B	C	PACKAGE
RS-187	9.0	4.2	6.3	2000
RS-188	9.5	4.2	6.3	2000
RS-189	10.0	4.2	6.3	2000
RS-190	11.0	4.2	6.3	2000
RS-191	12.0	4.2	6.3	2000
RS-192	12.7	4.2	6.3	1000
RS-193	13.0	4.2	6.3	1000
RS-194	14.0	4.2	6.3	1000
RS-195	15.0	4.2	6.3	1000
RS-196	16.0	4.2	6.3	1000
RS-197	17.0	4.2	6.3	1000
RS-198	18.0	4.2	6.3	1000
RS-199	19.0	4.2	6.3	1000
RS-200	20.0	4.2	6.3	1000
RS-201	21.0	4.2	6.3	1000
RS-202	22.0	4.2	6.3	1000
RS-203	23.0	4.2	6.3	1000
RS-204	24.0	4.2	6.3	1000
RS-205	25.0	4.2	6.3	1000
RS-206	26.0	4.2	6.3	1000
RS-207	27.0	4.2	6.3	1000
RS-208	28.0	4.2	6.3	1000
RS-209	28.7	4.2	6.3	1000
RS-210	29.0	4.2	6.3	1000
RS-211	30.0	4.2	6.3	1000
RS-212	40.0	4.2	6.3	1000
RS-213	45.0	4.2	6.3	1000
RS-214	3.4	4.2	6.3	1000
RS-307	6.4	3.5	6.3	1000
RS-347	12.7	3.5	6.3	1000

PART NO	A	B	C	PACKAGE
RS-158	15.5	3.5	6.3	1000
RS-159	16.0	3.5	6.3	1000
RS-160	17.0	3.5	6.3	1000
RS-161	17.7	3.5	6.3	1000
RS-162	18.0	3.5	6.3	1000
RS-163	19.0	3.5	6.3	1000
RS-164	20.0	3.5	6.3	1000
RS-165	21.0	3.7	6.3	1000
RS-166	22.0	3.5	6.3	1000
RS-167	23.0	3.5	6.3	1000
RS-168	24.0	3.7	6.3	1000
RS-169	25.0	3.7	6.3	1000
RS-170	26.0	3.7	6.3	1000
RS-171	27.0	3.7	6.3	1000
RS-172	28.0	3.7	6.3	1000
RS-173	28.57	3.55	6.35	1000
RS-174	29.0	3.7	6.3	1000
RS-175	30.0	3.7	6.3	1000
RS-176	35.0	3.7	6.3	1000
RS-177	3.0	4.2	6.3	2000
RS-178	3.5	4.2	6.3	2000
RS-179	4.0	4.2	6.3	2000
RS-180	4.83	4.2	6.3	2000
RS-181	5.0	4.2	6.3	2000
RS-182	6.0	4.2	6.3	2000
RS-183	7.0	4.2	6.3	2000
RS-184	7.5	4.2	6.3	2000
RS-185	8.0	4.2	6.3	2000
RS-186	8.5	4.2	6.3	2000

PART NO	A	B	C	PACKAGE
RS-43	1.6	3.5	6.3	2000
RS-45	2.0	4.2	6.3	2000
RS-140	2.0	3.5	6.3	2000
RS-141	3.0	3.5	6.3	2000
RS-142	3.5	3.5	6.3	2000
RS-143	4.0	3.5	6.3	2000
RS-144	4.5	3.5	6.3	2000
RS-145	5.0	3.5	6.3	2000
RS-146	6.0	3.5	6.3	2000
RS-147	7.0	3.5	6.3	2000
RS-148	7.5	3.5	6.3	2000
RS-149	8.0	3.5	6.3	2000
RS-150	9.0	3.5	6.3	2000
RS-151	9.5	3.5	6.3	2000
RS-152	10.	3.5	6.3	2000
RS-153	11.0	3.5	6.3	2000
RS-154	12.0	3.5	6.3	1000
RS-155	13.0	3.5	6.3	1000
RS-156	14.0	3.5	6.3	1000
RS-157	15.0	3.5	6.3	1000

圆体间隔柱 ROUND SPACER 直通隔离柱 直通间隔柱 直通管柱 圆体隔离柱

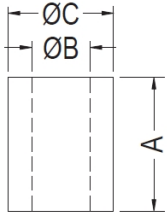
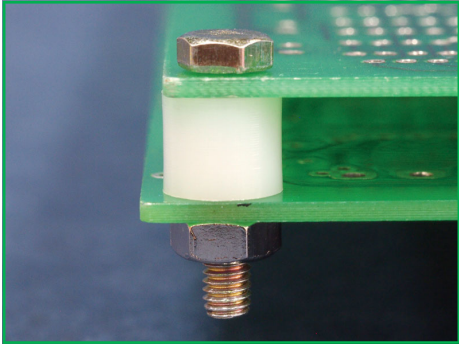

PART NO	A	B	C	PACKAGE
RS-38	9.4	2.4	4.8	1000
RS-39	16.0	2.5	5.5	1000
RS-41	3.85	3.15	5.0	1000
RS-42	4.0	3.15	5.0	1000
RS-100	4.0	1.6	4.0	1000
RS-101	5.0	3.1	6.0	1000
RS-102	7.5	3.1	8.0	1000
RS-139	25.0	3.0	6.0	1000
RS-232	2.2	3.1	8.0	1000
RS-235	6.71	2.7	6.35	1000
RS-236	6.8	3.2	4.5	1000

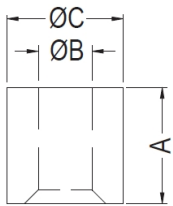

PART NO	A	B	C	PACKAGE
RS-36	5.0	2.3	5.0	1000
RS-37	5.5	2.3	5.0	1000

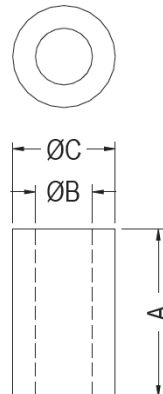

PART NO	A	B	C	PACKAGE
RS-349	20.0	3.2	6.0	1000
RS-350	38.1	3.05	6.35	1000

- ◆ MATERIAL : NYLON 66(UL)/POM/ PE/TPE/PC(UL)/ABS(UL)/PPS
- ◆ FLAME CLASS : 94V-0/94V-2/94HB
- ◆ COLOR : BLACK/NATURAL
- ◆ UNIT: mm

用途：圆体间隔柱作为电路板之垫高用，尺寸齐全。

PART NO	A	B	C	PACKAGE
RS-241	3.5	2.05	3.0	1000
RS-242	5.0	3.35	8.0	1000
RS-243	10.0	3.55	6.0	1000
RS-244	1.5	2.2	2.5	2000
RS-246	4.45	3.2	6.4	1000
RS-247	7.6	1.2	4.0	1000
RS-249	2.84	2.7	6.35	1000
RS-250	3.0	0.71	2.2	1000
RS-251	3.0	1.2	3.2	1000
RS-258	1.6	0.7	2.0	1000
RS-259	1.9	2.02	3.0	2000
RS-260	2.1	2.1	2.4	1000
RS-261	2.15	2.5	4.0	1000
RS-263	2.5	1.2	4.0	1000
RS-264	2.5	3.2	4.2	1000
RS-266	3.0	1.4	3.5	1000
RS-267	3.0	3.2	5.8	1000
RS-270	3.5	3.1	5.7	1000
RS-278	5.85	3.2	5.0	1000

PART NO	A	B	C	PACKAGE
RS-283	6.4	3.2	6.4	1000
RS-284	6.4	3.2	5.8	1000
RS-294	11.3	1.7	3.0	1000
RS-296	4.0	3.1	6.0	1000
RS-297	10.0	3.2	8.0	1000
RS-298	5.5	3.5	6.3	1000
RS-309	5.0	1.2	4.0	1000
RS-310	5.0	2.2	4.0	1000
RS-311	2.3	2.73	4.3	1000
RS-312	3.8	2.8	4.3	1000
RS-313	8.0	2.95	3.55	1000
RS-314	6.0	3.1	6.0	1000
RS-315	2.0	3.6	7.0	1000
RS-320	2.0	1.6	4.0	1000
RS-321	5.89	1.63	3.18	1000
RS-322	8.0	3.1	6.0	1000
RS-323	31.8	3.55	6.35	1000
RS-333	4.76	3.56	7.94	1000
RS-334	9.53	3.56	6.35	1000
RS-359	2.2	3.2	5.5	1000
RS-374	6.35	1.2	3.2	1000
RS-375	2.0	3.1	6.0	1000

# 圆体间隔柱 ROUND SPACER 直通隔离柱 直通间隔柱 直通管柱 圆体隔离柱

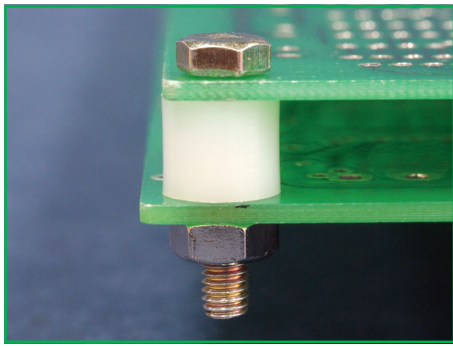

- ◆ MATERIAL : NYLON 66(UL)
- ◆ FLAME CLASS : 94V-0/90V-2
- ◆ COLOR : NATURAL/BLACK
- ◆ UNIT: mm

用途：圆体间隔柱作为电路板之垫高用，尺寸齐全。

圆体间隔柱

PART NO	A	B	C	PACKAGE
RS-44	19.0	3.6	8.0	1000
RS-221	19.9	4.5	6.1	250
RS-245	3.0	4.9	7.94	1000
RS-265	2.75	4.5	6.0	1000
RS-269	3.18	4.45	6.35	1000
RS-271	3.5	4.7	6.0	1000
RS-276	5.3	3.9	8.0	1000
RS-282	6.0	4.4	7.43	1000
RS-285	6.4	4.4	9.5	1000
RS-290	8.5	4.2	10.0	1000
RS-292	10.0	3.73	6.35	1000
RS-316	3.8	3.95	6.1	1000
RS-324	2.5	4.1	8.0	1000
RS-325	2.4	4.2	7.5	1000
RS-326	11.0	4.5	7.0	1000
RS-327	11.5	4.5	7.0	1000
RS-335	6.1	3.7	8.0	1000
RS-336	0.5	3.8	5.3	1000
RS-337	5.5	3.8	5.3	1000
RS-338	4.8	4.0	7.5	1000
RS-339	4.8	4.2	5.5	1000
RS-340	1.5	4.3	5.8	1000
RS-341	5.5	4.3	5.8	1000
RS-342	10.5	4.3	5.8	1000
RS-343	15.5	4.3	5.8	1000
RS-376	9.5	3.73	6.35	1000

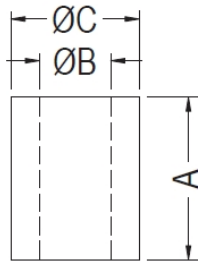

PART NO	A	B	C	PACKAGE
RS-46	3.5	5.0	9.0	1000
RS-47	4.00	5.0	9.0	500
RS-48	5.0	5.6	8.6	1000
RS-49	6.0	5.6	8.6	1000
RS-50	7.9	5.6	8.6	1000
RS-51	8.0	5.6	8.6	1000
RS-64	4.0	5.0	12.0	1000
RS-103	2.0	5.2	6.8	1000
RS-216	13.0	5.2	6.8	1000
RS-217	11.8	5.55	7.0	1000
RS-226	122.0	5.4	9.53	250
RS-239	4.0	5.5	15.0	1000
RS-262	2.3	5.2	6.8	1000
RS-268	3.0	5.2	6.8	1000
RS-272	4.1	5.2	6.8	1000
RS-286	6.5	5.0	9.5	1000
RS-287	7.5	5.2	7.6	1000
RS-289	7.9	5.0	9.5	1000
RS-293	11.0	5.2	7.6	1000
RS-299	12.7	5.1	9.5	1000
RS-308	8.8	5.6	8.6	1000
RS-328	4.2	5.0	7.0	1000
RS-344	6.0	5.2	10.0	1000
RS-351	38.1	5.0	7.9	500

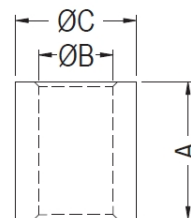

PART NO	A	B	C	PACKAGE
RS-228	13.0	4.9	7.94	1000
RS-234	4.5	4.9	7.94	1000
RS-238	11.5	4.9	7.94	1000

# 圆体间隔柱 ROUND SPACER 直通隔离柱 直通间隔柱 直通管柱 圆体隔离柱

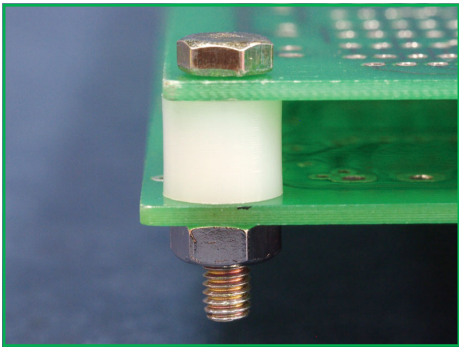

- ◆ MATERIAL : NYLON 66(UL)/POM/ PE/TPE/PC(UL)/ABS(UL)/PPS 用途: 圆体间隔柱作为电路板之垫高
- ◆ FLAME CLASS : 94V-0/94V-2/94HB 用, 尺寸齐全。
- ◆ COLOR : BLACK/NATURAL
- ◆ UNIT: mm

PART NO	A	B	C	PACKAGE
RS-52	11.8	5.6	8.6	1000
RS-53	14.0	5.6	8.6	1000
RS-54	16.5	5.6	8.6	1000
RS-55	16.7	5.6	8.6	1000
RS-56	17.0	5.6	8.6	1000
RS-57	20.0	5.6	8.6	250
RS-65	22.0	6.0	15.0	250
RS-104	5.0	6.3	15.0	1000
RS-215	12.0	6.2	10.4	1000
RS-218	15.7	6.6	9.1	1000
RS-222	20.0	6.3	12.7	250
RS-229	12.9	5.7	7.7	1000
RS-230	14.1	5.7	7.7	1000
RS-233	3.0	6.5	9.2	1000
RS-273	4.2	6.6	10.6	1000
RS-274	4.8	6.6	9.1	1000
RS-275	5.0	6.8	10.0	1000
RS-279	6.0	6.0	10.0	1000
RS-280	6.0	6.2	10.0	1000
RS-300	3.0	6.4	12.0	1000
RS-317	10.0	6.4	20.0	500
RS-345	4.9	5.8	7.3	1000
RS-346	14.4	5.8	7.3	1000

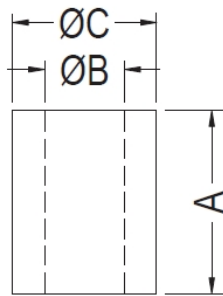

PART NO	A	B	C	PACKAGE
RS-58	7.9	8.5	11.0	1000
RS-66	6.0	10.0	12.0	250
RS-105	5.0	12.4	22.0	250
RS-219	15.7	8.1	10.7	1000
RS-220	16.0	29.5	33.5	1000
RS-223	26.0	10.0	12.0	250
RS-224	29.0	7.5	11.0	250
RS-225	35.0	12.8	22.0	250
RS-231	5.0	13.0	24.0	250
RS-237	8.7	7.0	10.0	1000
RS-240	4.6	8.5	10.3	1000
RS-248	9.5	20.5	25.5	250
RS-277	5.5	7.0	13.0	1000
RS-281	6.0	8.5	12.0	1000
RS-288	7.1	9.5	17.9	1000
RS-291	8.9	7.5	10.0	1000
RS-295	4.0	9.25	12.25	1000
RS-301	12.7	6.9	12.7	1000
RS-302	5.0	8.4	16.0	1000
RS-318	5.5	8.2	12.0	1000
RS-319	34.0	9.5	19.0	250
RS-352	19.0	12.0	14.0	250

圆体间隔柱 ROUND SPACER 直通隔离柱 直通间隔柱 直通管柱 圆体隔离柱



- ◆ MATERIAL : NYLON 66(UL)
- ◆ FLAME CLASS : 90V-2
- ◆ COLOR : BLACK
- ◆ UNIT: mm

用途：圆体间隔柱用于零件之隔离与固定。

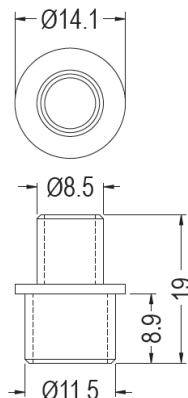
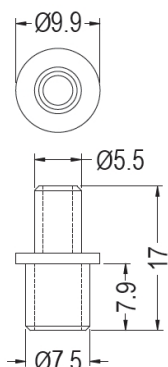

PART NO	PACKAGE
RS-59	1000

PART NO	PACKAGE
RS-60	1000

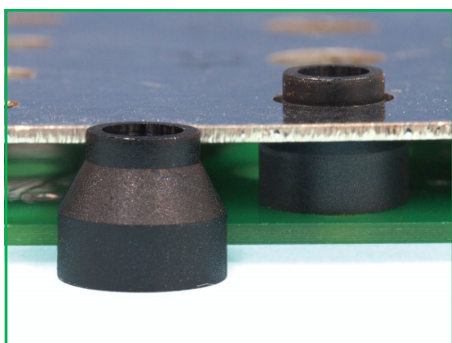

- ◆ MATERIAL : NYLON 66(UL)
- ◆ FLAME CLASS : 90V-2/94V-0
- ◆ COLOR : BLACK/NATURAL
- ◆ UNIT: mm

用途：圆体间隔柱用于板件与机板间之垫高与固定用。

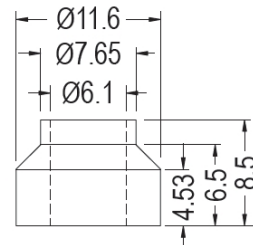
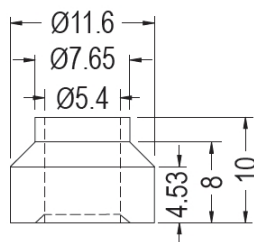

PART NO	PACKAGE
RS-67	500

PART NO	PACKAGE
RS-305	500



- ◆ MATERIAL : ABS (UL)
- ◆ FLAME CLASS : 94HB
- ◆ COLOR : NATURAL
- ◆ UNIT: mm

用途：圆体间隔柱用于电路板与机板间之垫高与绝缘固定用。

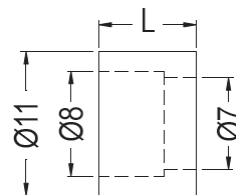
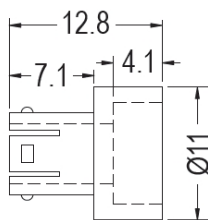

P.C.B Ø7.5  
CHASSIS Ø4.5

PART NO	PACKAGE
RS-69	1000

PART NO	L	PACKAGE	
RS-69	RS-70	5.7	1000
	RS-71	7.5	1000
	RS-72	10.3	1000
	RS-73	15.0	500
	RS-353	20.0	500
	RS-354	25.4	500

圆体间隔柱 ROUND SPACER 直通隔离柱 直通间隔柱 直通管柱 圆体隔离柱



- ◆ MATERIAL : ABS (UL)
- ◆ FLAME CLASS : 94HB
- ◆ COLOR : NATURAL
- ◆ UNIT: mm

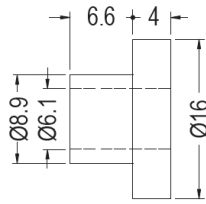

P.C.B Ø9.0  
CHASSIS Ø6.0

PART NO	PACKAGE
RS-89	1000

用途：圆体间隔柱用于电路板与机板间之垫高与绝缘固定用。

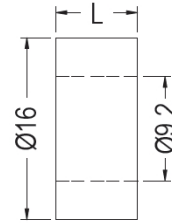

PART NO	L	PACKAGE
RS-89	RS-90	5.0
	RS-91	7.0
	RS-92	10.0

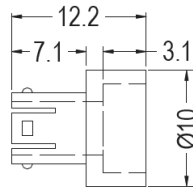

P.C.B Ø6.5  
CHASSIS Ø4.0

PART NO	PACKAGE
RS-76	1000

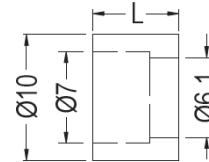

PART NO	L	PACKAGE
RS-76	RS-77	7.5
	RS-78	10.0
	RS-79	15.0

- ◆ MATERIAL : NYLON 66 (UL)
- ◆ FLAME CLASS : 94V-2/94V-0
- ◆ COLOR : NATURAL/BLACK
- ◆ UNIT: mm

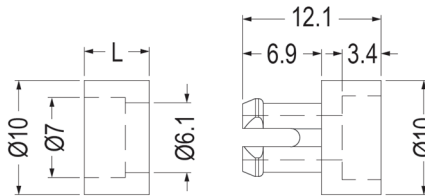

P.C.B Ø6.5  
THICKNESS Ø2.4

PART NO	L	PACKAGE
RS-371	RS-372	5.7
	RS-373	20.0

PART NO	L	PACKAGE
RS-371	RS-372	5.7
	RS-373	20.0

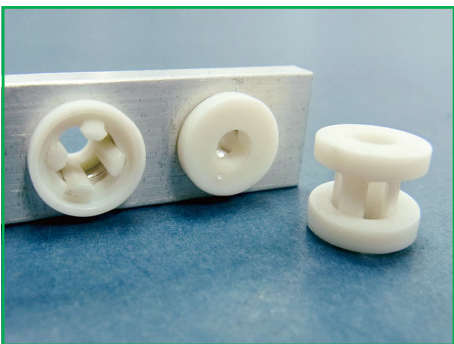

- ◆ MATERIAL : NYLON 66 (UL)
- ◆ FLAME CLASS : 94V-2/94V-0
- ◆ COLOR : NATURAL/BLACK
- ◆ UNIT: mm

用途：圆体间隔柱用于电路板与机板间之垫高与绝缘固定用。

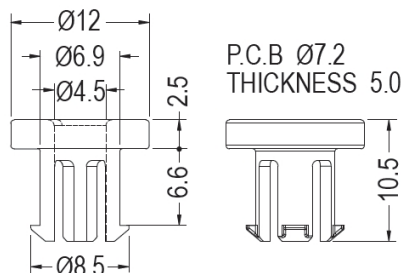

P.C.B Ø7.2  
THICKNESS 5.0

PART NO	PACKAGE
RS-74	1000

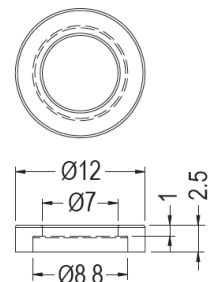

PART NO	PACKAGE
RS-75	1000



圆体间隔柱 ROUND SPACER 直通隔离柱 直通间隔柱 直通管柱 圆体隔离柱



- ◆ MATERIAL : NYLON 66(UL)
- ◆ FLAME CLASS : 90V-2/94V-2
- ◆ COLOR : NATURAL
- ◆ UNIT: mm

用途：圆体间隔柱用于PCB电路板与机板间之垫高与固定用。

PART NO	L	PACKAGE	
RS-82	6.0	1000	
RS-83	7.8	1000	
RS-84	10.5	1000	
RS-81	RS-85	15.0	500
RS-86	18.0	500	
RS-87	20.0	500	
RS-88	25.0	500	

PART NO	PACKAGE
RS-81	1000

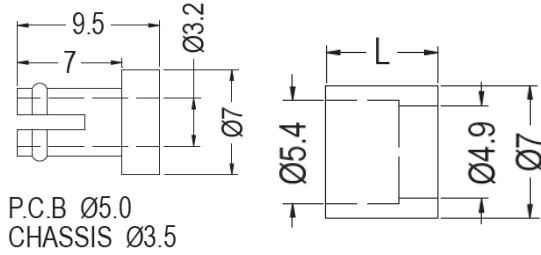

- ◆ MATERIAL : POM (UL)
- ◆ FLAME CLASS : 94HB
- ◆ COLOR : BLACK/NATURAL
- ◆ UNIT: mm

用途：圆体间隔柱用于板件与机板间之垫高与固定用。

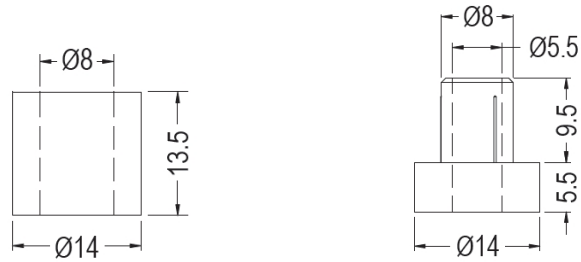

PART NO	PACKAGE
RS-94	500

PART NO	PACKAGE
RS-93	500

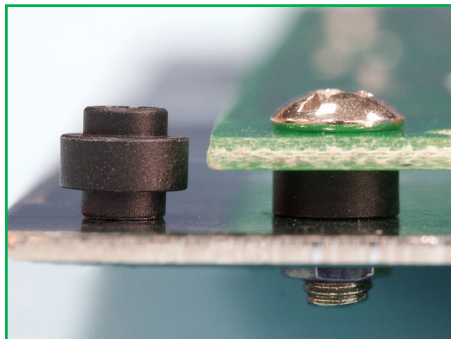

- ◆ MATERIAL : NYLON 6T(UL)
- ◆ FLAME CLASS : 94V-0
- ◆ COLOR : BLACK
- ◆ UNIT: mm

用途：圆体间隔柱用于电路板与机板之绝缘用。

MOUNTING HOLE Ø4.5

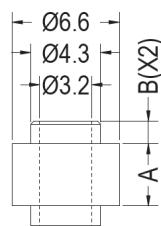

MOUNTING HOLE Ø4.5

PART NO	A	B	PACKAGE
RS-106	2.9	0.7	1000
RS-256	2.7	1.5	1000
RS-304	3.85	1.4	1000
RS-375	3.0	0.7	1000
RS-378	3.0	0.7	1000

圆体间隔柱 ROUND SPACER 直通隔离柱 直通间隔柱 直通管柱 圆体隔离柱

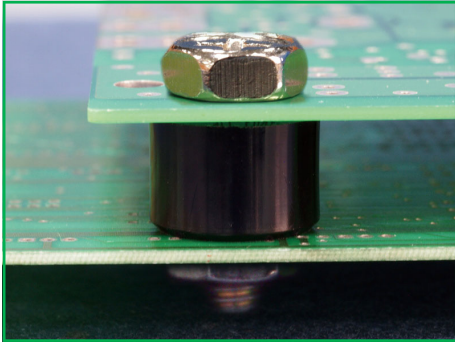

- ◆ MATERIAL : NYLON 66(UL)
- ◆ FLAME CLASS : 94V-0/94V-2
- ◆ COLOR : NATURAL/BLACK
- ◆ UNIT: mm

用途：圆体间隔柱用于电路板与机板之绝缘用。

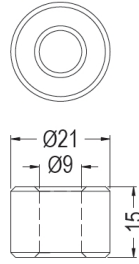

PART NO	PACKAGE
RS-252	1000

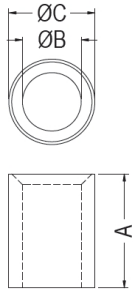
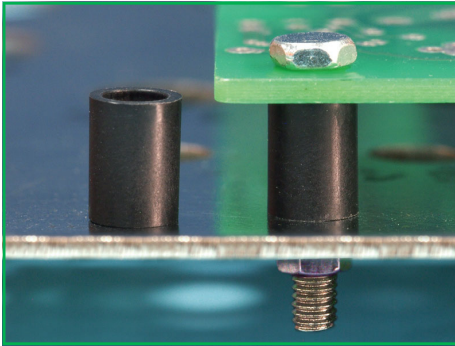

PART NO	A	B	C	PACKAGE
RS-355	8.0	4.1	6.0	1000
RS-356	2.0	4.1	6.0	1000

圆体间隔柱

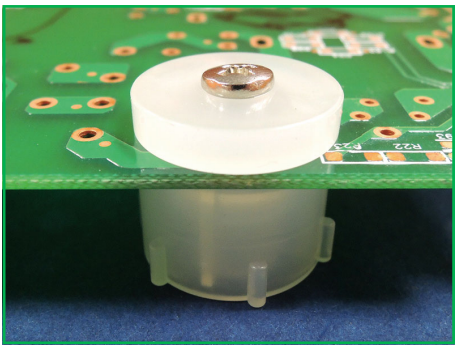

- ◆ MATERIAL : PC (UL)
- ◆ FLAME CLASS : 94V-0
- ◆ COLOR : NATURAL
- ◆ UNIT: mm

用途：圆体间隔柱用于电路板与机板间之垫高与绝缘固定用。

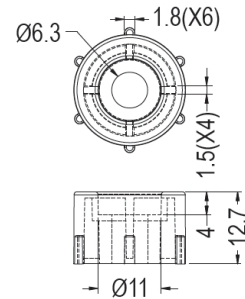
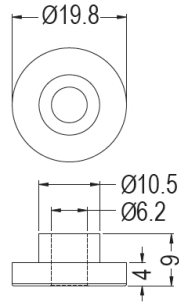

PART NO	PACKAGE
RS-254	1000

PART NO	PACKAGE
RS-255	1000



- ◆ MATERIAL : PC (UL)
- ◆ FLAME CLASS : 94V-0
- ◆ COLOR : NATURAL
- ◆ UNIT: mm

用途：圆体间隔柱用于零件之绝缘使用。

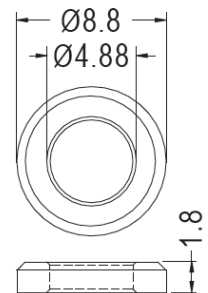
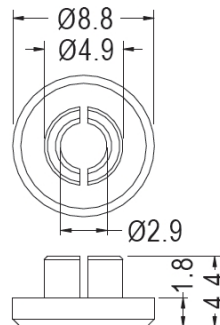

PART NO	PACKAGE
RS-360	组合使用
RS-361	

PART NO	PACKAGE
RS-360	1000

PART NO	PACKAGE
RS-361	1000

圆体间隔柱 ROUND SPACER 直通隔离柱 直通间隔柱 直通管柱 圆体隔离柱

圆体间隔柱



- ◆ MATERIAL : NYLON 66(UL)
- ◆ FLAME CLASS : 94V-2
- ◆ COLOR : NATURAL
- ◆ UNIT: mm

用途：圆体间隔柱用于电路板与机板之绝缘用。

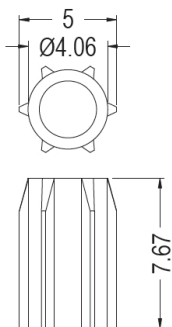

PART NO	PACKAGE
RS-348	1000

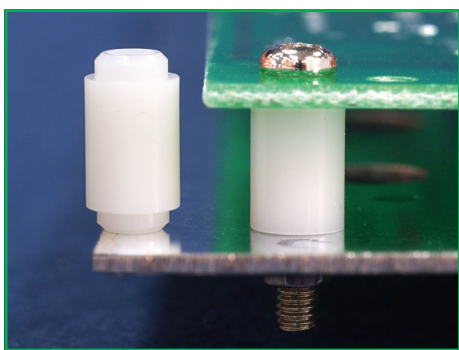

- ◆ MATERIAL : ABS(UL)
- ◆ FLAME CLASS : 94HB
- ◆ COLOR : NATURAL
- ◆ UNIT: mm

用途：圆体间隔柱用于电路板与机板之绝缘用。

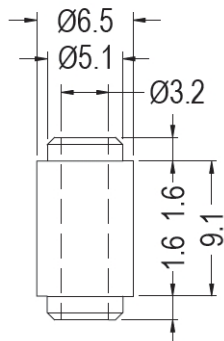

PART NO	PACKAGE
RS-61	1000

- ◆ MATERIAL : NYLON 66(UL)
- ◆ FLAME CLASS : 94V-0/94V-2
- ◆ COLOR : BLACK/NATURAL
- ◆ UNIT: mm

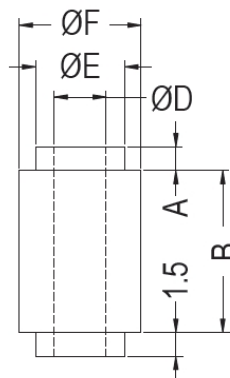

PART NO	A	B	D	E	F	PACKAGE
RS-63	1.5	10.0	3.2	5.5	7.5	1000
RS-357	1.0	74.5	6.5	8.0	10.0	1000

圆体间隔柱 ROUND SPACER 直通隔离柱 直通间隔柱 直通管柱 圆体隔离柱



- ◆ MATERIAL : NYLON 6T
- ◆ COLOR : BLACK
- ◆ UNIT: mm

用途：圆体间隔柱用于螺丝或机板之绝缘使用。

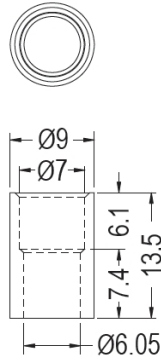

PART NO	PACKAGE
RS-62	1000

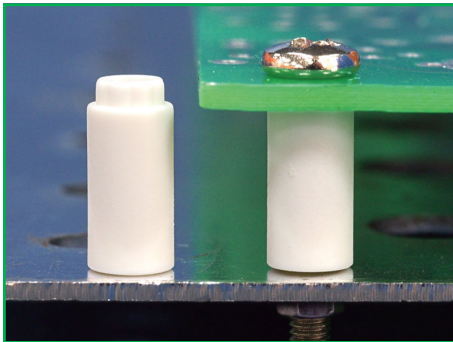

- ◆ MATERIAL : PBT (UL)
- ◆ FLAME CLASS : 94V-0
- ◆ COLOR : NATURAL/BLACK
- ◆ UNIT: mm

用途：圆体间隔柱用于电路板与机板间之垫高与绝缘固定用。

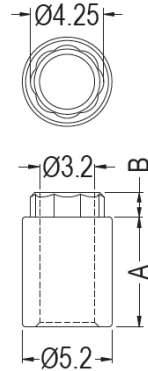
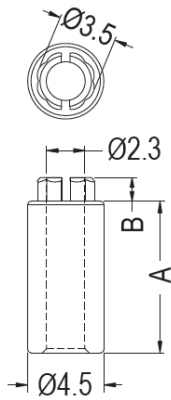

PART NO	A	B	PACKAGE
RS-358	6.2	1.0	1000
RS-362	9.0	1.4	1000

PART NO	A	B	PACKAGE
RS-363	6.4	1.4	1000
RS-364	7.07	1.4	1000
RS-365	9.43	1.4	1000
RS-366	10.06	1.4	1000

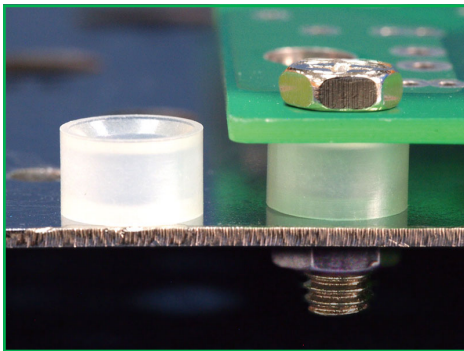

- ◆ MATERIAL : PC (UL)
- ◆ FLAME CLASS : 94V-0/94V-0
- ◆ COLOR : NATURAL
- ◆ UNIT: mm

用途：圆体间隔柱用于电路板与机板之绝缘用。

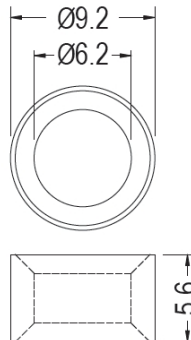

PART NO	A	B	C	PACKAGE
RS-367	5.6	6.2	9.2	1000

圆体间隔柱 ROUND SPACER 直通隔离柱 直通间隔柱 直通管柱 圆体隔离柱

圆体间隔柱

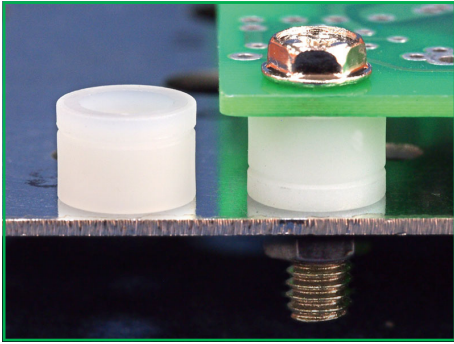

- ◆ MATERIAL : NYLON 66(UL)
- ◆ FLAME CLASS : 94V-2/94V-0
- ◆ COLOR : NATURAL/BLACK
- ◆ UNIT: mm

用途：圆体间隔柱用于电路板与机板之绝缘用。

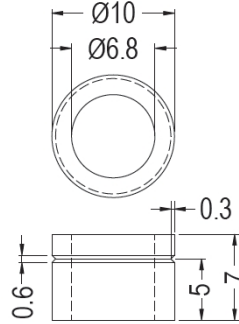

PART NO	PACKAGE
RS-368	1000

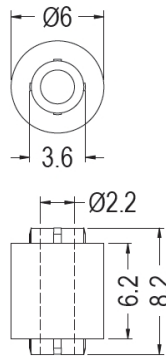
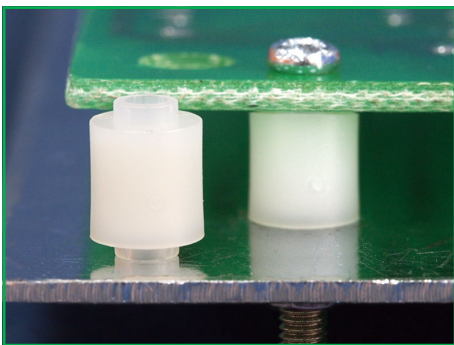

MOUNTING HOLE Ø3.5

PART NO	PACKAGE
RS-369	1000



- ◆ MATERIAL : NYLON 66(UL)
- ◆ FLAME CLASS : 94V-0/94V-2
- ◆ COLOR : BLACK/NATURAL
- ◆ UNIT: mm

用途：圆体间隔柱用于电路板与机板之绝缘用。

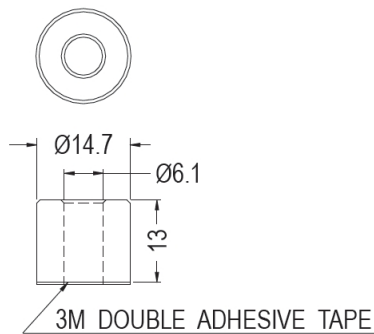

PART NO	PACKAGE
RS-370	1000

# PCB板固定片 PC BRACKET

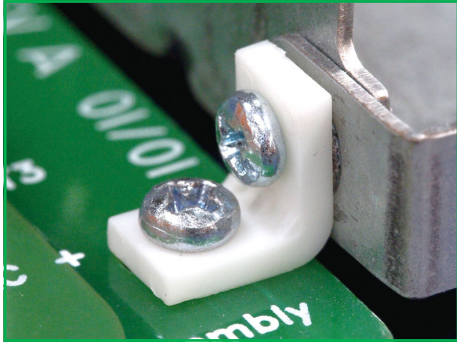

- ◆ MATERIAL : NYLON 66 (UL)
- ◆ FLAME CLASS : 94V-0 / 94V-2
- ◆ COLOR : NATURAL/BLACK
- ◆ UNIT: mm

用途： PCB板固定片用于快速固定电路板于机板上。

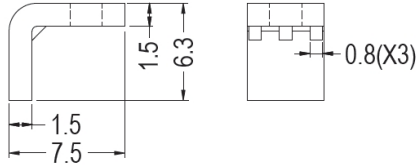
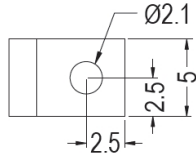

PART NO	PACKAGE
GDK-18	1000

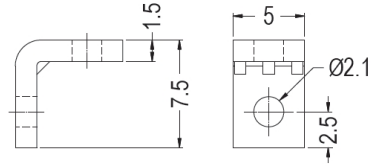
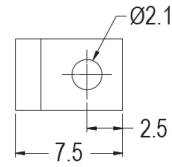

PART NO	PACKAGE
GDK-22	1000

PCB板固定片

# PCB板固定座 SPACER SUPPORT 螺丝固定



- ◆ MATERIAL : PC(UL)
- ◆ FLAME CLASS : 94V-2
- ◆ COLOR : TRANSPARENT
- ◆ UNIT: mm

用途： PCB板固定座配合螺丝，固定电路板于机板上。

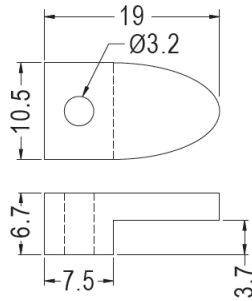

PART NO	PACKAGE
PCZ-4	1000

PCB板固定座

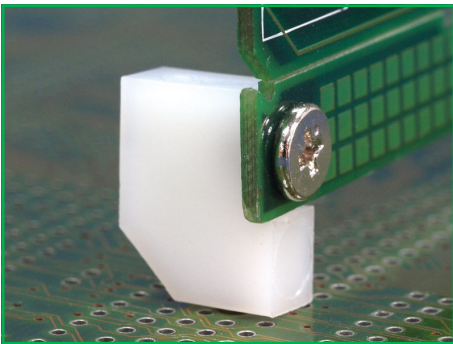

- ◆ MATERIAL : NYLON 66(UL)
- ◆ FLAME CLASS : 94V-0/94V-2
- ◆ COLOR : BLACK/NATURAL
- ◆ UNIT: mm

用途： PCB板固定座用于电路板固定，使电路板与机板成 90° 固定。

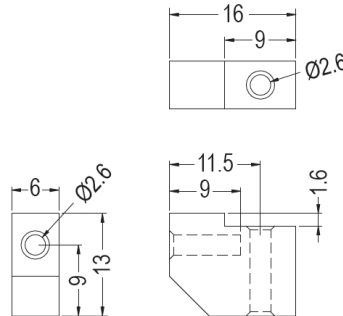
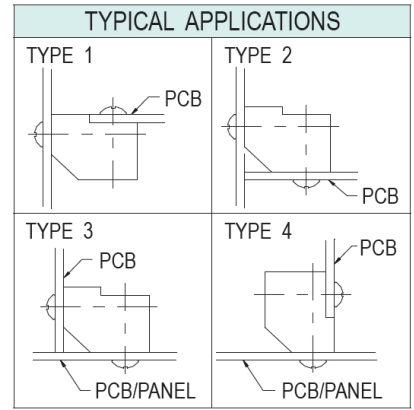

PART NO	PACKAGE
PCZ-2	500

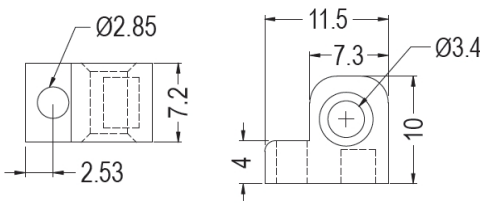
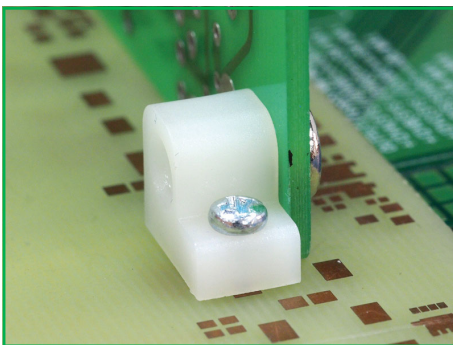

PART NO	PACKAGE
PCZ-3	1000

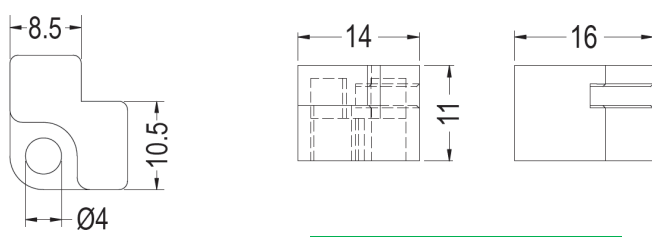
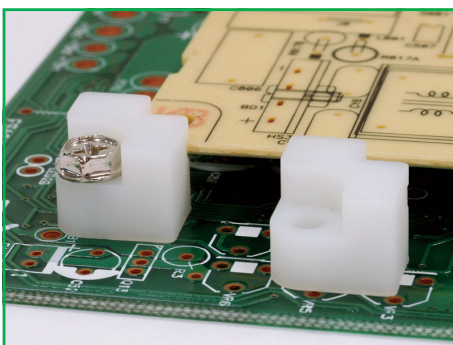

PART NO	PACKAGE
PCSS-1858	1000

# PCB板固定扣 PCB HINGE

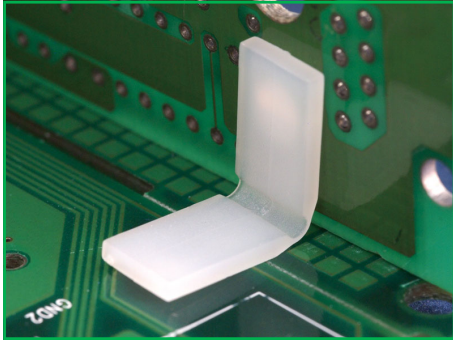

- ◆ MATERIAL : NYLON 66 (UL)
- ◆ FLAME CLASS : 94V-0 / 94V-2
- ◆ COLOR : NATURAL/BLACK
- ◆ UNIT: mm

用途： PCB板固定扣一端固定于机板或电路板上，另一端固定于电路板上成90度。

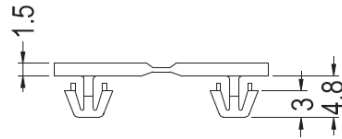

P.C.B Ø4.0  
THICKNESS 1.6~1.8

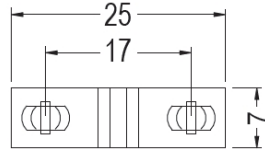

PART NO	PACKAGE
PCBG01	1000

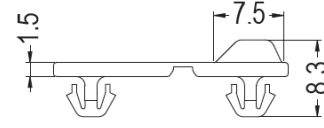

P.C.B Ø4.0  
THICKNESS 1.6

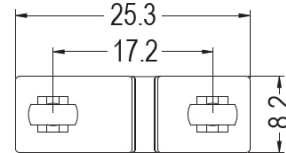

PART NO	PACKAGE
PCBG03	1000

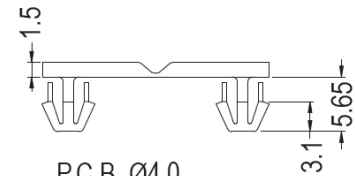

P.C.B Ø4.0  
THICKNESS 2.36

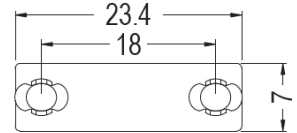

PART NO	PACKAGE
PCBG04	1000

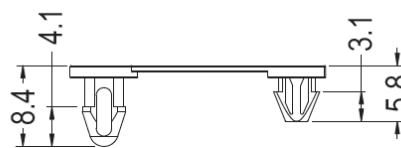

P.C.B Ø4.0  
THICKNESS 3.0

P.C.B Ø3.8  
THICKNESS 1.4

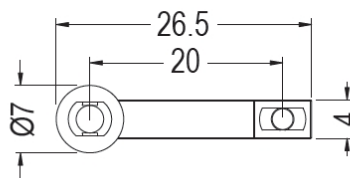

PART NO	PACKAGE
PCBG02	1000



# 绝缘柱 ROUNDER WASHER 垫圈 垫片 华司



- ◆ MATERIAL : NYLON 66 (UL)/ NYLON 6(UL)/PC (UL)
- ◆ FLAME CLASS : 94V-0/94V-2
- ◆ COLOR : NATURAL/BLACK
- ◆ UNIT: mm

用途：绝缘柱，做为PC板与机板之绝缘使用。

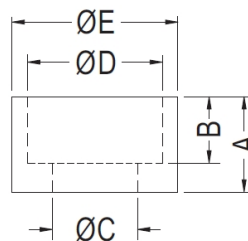

PART NO	A	B	C	D	E	PACKAGE
RDSC-36	4.9	3.8	3.2	5.7	7.0	2000
RDSC-37	4.6	3.2	4.1	6.5	8.0	2000
RDSC-38	10.0	7.0	3.0	8.5	11.0	1000
RDSC-39	3.1	2.1	3.0	5.5	7.5	2000
RDSC-40	3.0	1.5	3.7	7.4	9.4	2000
RDSC-41	4.6	3.6	3.6	7.6	9.1	2000
RDSC-42	4.0	3.0	2.9	6.3	7.8	2000
RDSC-43	4.2	2.7	3.2	5.3	8.74	2000
RDSC-44	6.5	6.0	6.0	8.0	9.0	2000
RDSC-45	7.1	5.1	4.8	8.9	15.7	2000
RDSC-46	5.1	4.0	7.0	10.0	12.0	2000
RDSC-47	3.8	2.25	3.4	5.95	8.0	2000

PART NO	A	B	C	D	E	PACKAGE
RDSC-48	4.8	3.3	3.4	6.5	9.5	2000
RDSC-49	3.8	3.05	3.2	5.4	7.0	2000
RDSC-50	6.4	3.4	3.2	5.0	7.0	2000
RDSC-51	6.0	3.0	2.8	5.1	7.5	2000
RDSC-52	4.8	2.5	6.8	4.5	12.5	2000
RDSC-53	4.5	3.75	3.1	4.2	6.0	2000
RDSC-54	6.5	6.0	3.5	6.0	8.0	2000
RDSC-55	3.75	2.65	3.2	5.4	7.0	2000
RDSC-56	2.3	1.7	3.25	5.5	6.7	2000
RDSC-57	5.0	4.6	-	4.5	5.2	2000
RDSC-69	2.5	2.0	3.5	6.0	7.0	2000
RDSC-70	5.1	4.0	3.2	10.0	12.0	2000
RDSC-71	3.5	3.0	-	7.0	8.7	2000
RDSC-72	20.0	17.5	5.2	14.0	17.0	1000

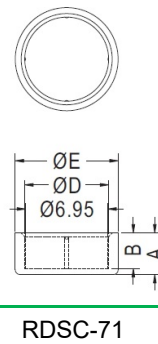
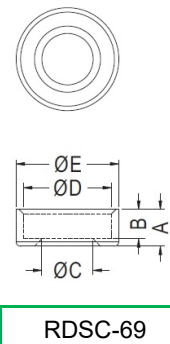
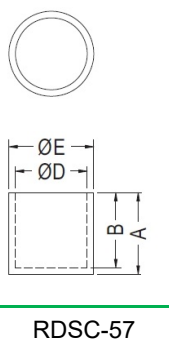
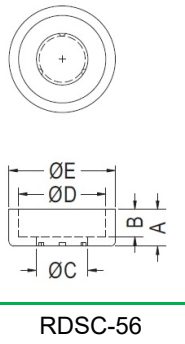
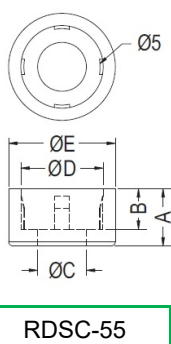
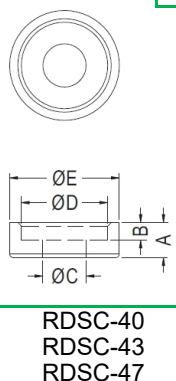
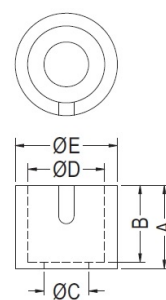
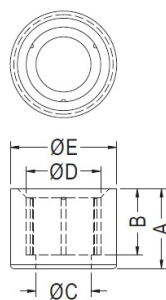
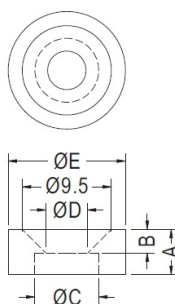
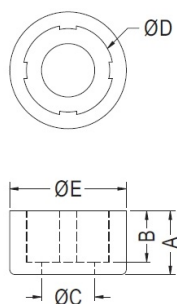
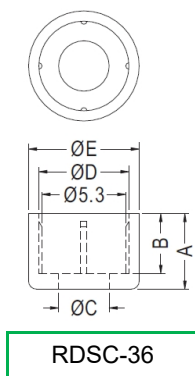

# 绝缘柱 ROUNDER WASHER 垫圈 垫片 华司



- ◆ MATERIAL : PC (UL)
- ◆ FLAME CLASS : 94V-0/94V-2
- ◆ COLOR : TRANSPARENT
- ◆ UNIT: mm

用途：绝缘柱，做为PC板与机板之绝缘使用。

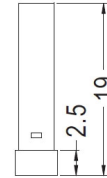
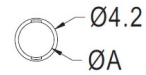
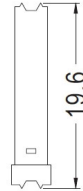
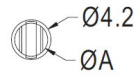

PART NO	A	PACKAGE
RDSC-65	3.5	1000
RDSC-66	3.0	1000

PART NO	A	PACKAGE
RDSC-61	3.5	1000
RDSC-62	3.0	1000



- ◆ MATERIAL : NYLON 66 (UL)/PPS(UL)
- ◆ FLAME CLASS : 94V-0
- ◆ COLOR : NATURAL/BLACK
- ◆ UNIT: mm

用途：绝缘柱，做为PC板与机板之绝缘使用。

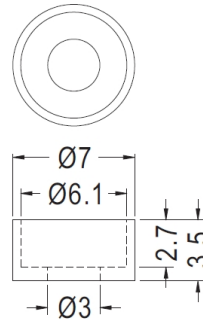

PART NO	PACKAGE
RDSC-54	2000

## 隔离柱 SPACER 间隔柱



- ◆ MATERIAL : PC(UL)
- ◆ FLAME CLASS : 94V-2
- ◆ COLOR : NATURAL/BLACK
- ◆ UNIT: mm

用途：隔离柱,也称间隔柱,用于零件之固定。

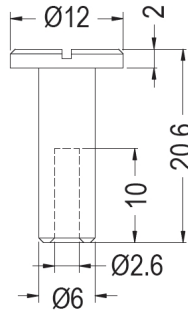

PART NO	PACKAGE
JGZ-0001	1000

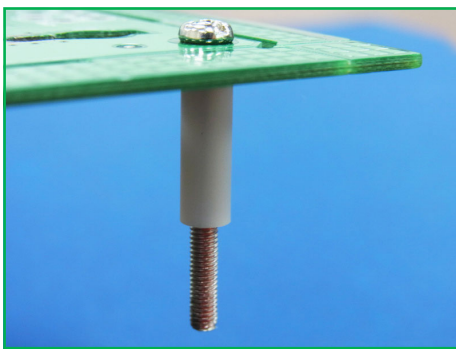

- ◆ MATERIAL : NYLON 66(UL)
- ◆ FLAME CLASS : 94V-0/94V-2
- ◆ COLOR : BLACK/NATURAL
- ◆ UNIT: mm

用途：隔离柱,也称电路板隔离柱,作为电路板与电路板或机板间之固定不掉落。

PART NO	A	PACKAGE
JGZ-0002	2.0	2000
JGZ-0003	3.0	2000
JGZ-0004	4.0	2000
JGZ-0005	5.0	2000
JGZ-0006	6.0	2000
JGZ-0007	7.0	2000
JGZ-0008	8.0	2000
JGZ-0009	9.0	2000
JGZ-0010	10.0	2000
JGZ-0011	11.0	2000
JGZ-0012	12.0	2000
JGZ-0013	12.7	2000
JGZ-0014	13.0	2000
JGZ-0015	14.0	2000
JGZ-0016	15.0	2000
JGZ-0017	16.0	2000

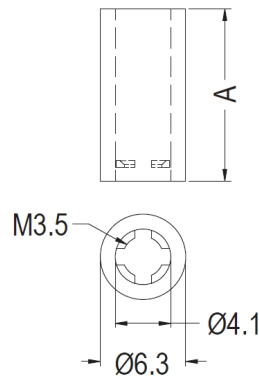

PART NO	A	PACKAGE
JGZ-0018	17.0	2000
JGZ-0019	18.0	2000
JGZ-0020	19.0	2000
JGZ-0021	20.0	1000
JGZ-0022	21.0	1000
JGZ-0023	22.0	1000
JGZ-0024	23.0	1000
JGZ-0025	24.0	1000
JGZ-0026	25.0	1000
JGZ-0027	26.0	1000
JGZ-0028	27.0	1000
JGZ-0029	28.0	1000
JGZ-0030	29.0	1000
JGZ-0031	30.0	1000
JGZ-0032	6.3	2000
JGZ-0033	15.9	2000
JGZ-0139	25.1	1000

# 隔离柱 SPACER SUPPORT 间隔柱 电路板隔离柱

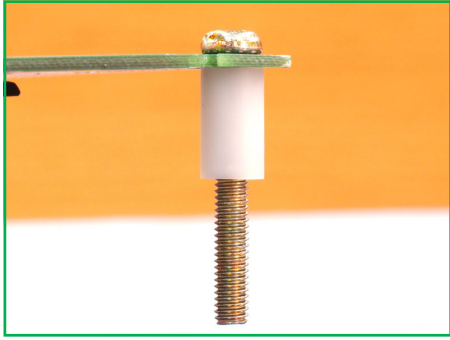

- ◆ MATERIAL : NYLON 66 (UL)
- ◆ FLAME CLASS : 94V-0/94V-2
- ◆ COLOR : NATURAL/BLACK
- ◆ UNIT: mm

用途： 隔离柱,也称电路板隔离柱，作为电路板与电路板或机板间之固定不掉落。

PART NO	A	PACKAGE
JGZ-0034	2.0	2000
JGZ-0035	3.0	2000
JGZ-0036	4.0	2000
JGZ-0037	5.0	2000
JGZ-0038	6.0	2000
JGZ-0039	7.0	2000
JGZ-0040	8.0	2000
JGZ-0041	9.0	2000
JGZ-0042	10.0	2000
JGZ-0043	11.0	2000
JGZ-0044	12.0	2000
JGZ-0045	12.7	2000
JGZ-0046	13.0	2000
JGZ-0047	14.0	2000
JGZ-0048	15.0	2000
JGZ-0049	16.0	2000
JGZ-0050	17.0	2000
JGZ-0051	18.0	2000

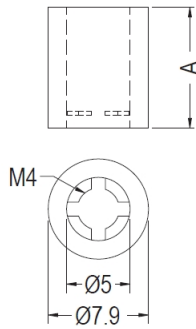
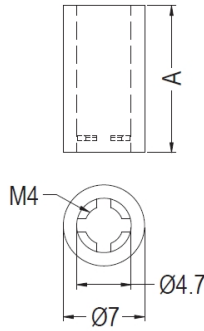

JGZ-0140

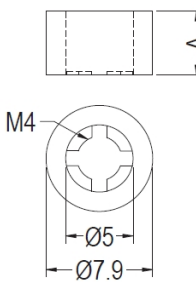

JGZ-0181 JGZ-0182

PART NO	A	PACKAGE
JGZ-0052	19.0	2000
JGZ-0053	20.0	1000
JGZ-0054	21.0	1000
JGZ-0055	22.0	1000
JGZ-0056	23.0	1000
JGZ-0057	24.0	1000
JGZ-0058	25.0	1000
JGZ-0059	26.0	1000
JGZ-0060	27.0	1000
JGZ-0061	28.0	1000
JGZ-0062	29.0	1000
JGZ-0063	30.0	1000
JGZ-0064	6.3	2000
JGZ-0065	15.9	2000
JGZ-0066	25.4	1000
JGZ-0140	9.5	2000
JGZ-0181	3.2	2000
JGZ-0182	4.8	2000

# 隔离柱 SPACER 间隔柱 电路板隔离柱

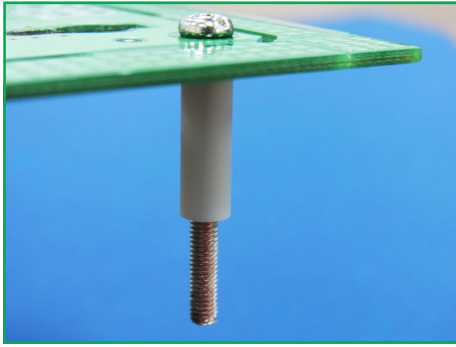

- ◆ MATERIAL : NYLON 66(UL)
- ◆ FLAME CLASS : 94V-0/94V-2
- ◆ COLOR : BLACK/NATURAL
- ◆ UNIT: mm

用途： 隔离柱,也称电路板隔离柱，作为电路板与电路板或机板间之固定不掉落。

PART NO	A	PACKAGE
JGZ-0067	2.0	2000
JGZ-0068	3.0	2000
JGZ-0069	4.0	2000
JGZ-0070	5.0	2000
JGZ-0071	6.0	2000
JGZ-0072	6.3	2000
JGZ-0073	7.0	2000
JGZ-0074	8.0	2000
JGZ-0075	9.0	2000
JGZ-0076	9.5	2000
JGZ-0077	10.0	2000
JGZ-0078	11.0	2000
JGZ-0079	12.0	2000
JGZ-0080	13.0	2000
JGZ-0081	14.0	2000
JGZ-0082	15.0	2000
JGZ-0083	15.9	2000

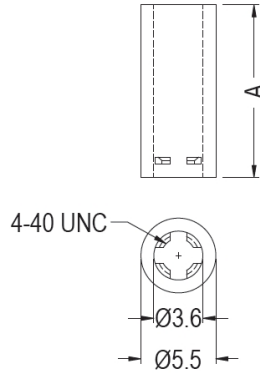

PART NO	A	PACKAGE
JGZ-0084	16.0	2000
JGZ-0085	17.0	2000
JGZ-0086	18.0	2000
JGZ-0087	19.0	1000
JGZ-0088	20.0	1000
JGZ-0089	21.0	1000
JGZ-0090	22.0	1000
JGZ-0091	23.0	1000
JGZ-0092	24.0	1000
JGZ-0093	25.0	1000
JGZ-0094	25.4	1000
JGZ-0095	26.0	1000
JGZ-0096	27.0	1000
JGZ-0097	28.0	1000
JGZ-0098	29.0	2000
JGZ-0099	30.0	2000
JGZ-0100	12.7	1000

# 隔离柱 SPACER SUPPORT 间隔柱 电路板隔离柱

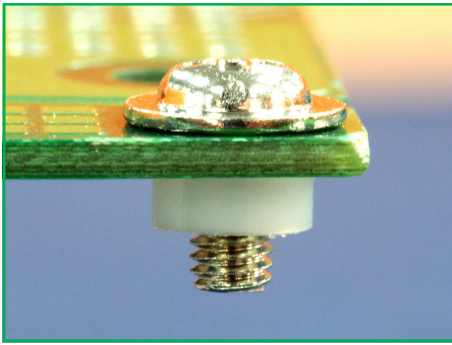

- ◆ MATERIAL : NYLON 66 (UL)
- ◆ FLAME CLASS : 94V-0/94V-2
- ◆ COLOR : TRANSPARENT/BLACK
- ◆ UNIT: mm

用途： 隔离柱,也称电路板隔离柱，作为电路板与电路板或机板间之固定不掉落。

PART NO	A	PACKAGE
JGZ-0103	3.5	2000
JGZ-0104	2.0	2000
JGZ-0105	3.0	2000
JGZ-0106	4.0	2000
JGZ-0107	5.0	2000
JGZ-0108	6.0	2000
JGZ-0109	7.0	2000
JGZ-0110	8.0	2000
JGZ-0111	9.0	2000
JGZ-0112	10.0	2000
JGZ-0113	11.0	2000
JGZ-0114	12.0	2000
JGZ-0115	12.7	2000
JGZ-0116	13.0	2000
JGZ-0117	14.0	2000
JGZ-0118	15.0	2000
JGZ-0119	16.0	2000
JGZ-0120	17.0	2000
JGZ-0121	18.0	2000
JGZ-0122	19.0	2000

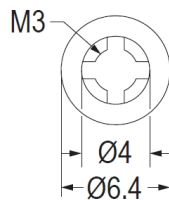
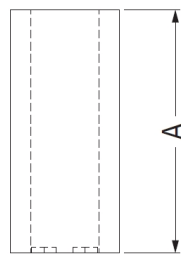
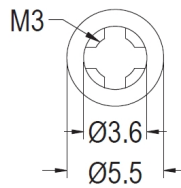
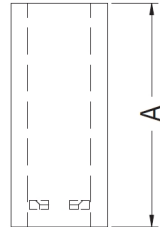

JGZ-0179 JGZ-0180

PART NO	A	PACKAGE
JGZ-0123	20.0	2000
JGZ-0124	21.0	1000
JGZ-0125	22.0	1000
JGZ-0126	23.0	1000
JGZ-0127	24.0	1000
JGZ-0128	25.0	1000
JGZ-0129	26.0	1000
JGZ-0130	27.0	1000
JGZ-0131	28.0	1000
JGZ-0132	29.0	1000
JGZ-0133	30.0	1000
JGZ-0134	6.3	2000
JGZ-0135	9.5	2000
JGZ-0136	15.9	2000
JGZ-0137	25.4	1000
JGZ-0138	11.5	2000
JGZ-0178	1.5	2000
JGZ-0179	3.2	2000
JGZ-0180	14.3	2000

# 隔离柱 SPACER 间隔柱 电路板隔离柱

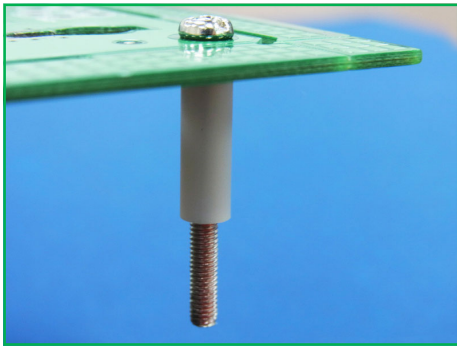

- ◆ MATERIAL : NYLON 66(UL)
- ◆ FLAME CLASS : 94V-0/94V-2
- ◆ COLOR : BLACK/NATURAL
- ◆ UNIT: mm

用途： 隔离柱,也称电路板隔离柱，作为电路板与电路板或机板间之固定不掉落。

PART NO	A	PACKAGE
JGZ-0141	1.57	2000
JGZ-0142	2.0	2000
JGZ-0143	3.0	2000
JGZ-0144	3.5	2000
JGZ-0145	4.0	2000
JGZ-0146	5.0	2000
JGZ-0147	6.0	2000
JGZ-0148	6.3	2000
JGZ-0149	7.0	2000
JGZ-0150	8.0	2000
JGZ-0151	9.0	2000
JGZ-0152	9.5	2000
JGZ-0153	10.0	2000
JGZ-0154	11.0	2000
JGZ-0155	11.5	2000
JGZ-0156	12.0	2000
JGZ-0157	12.7	2000
JGZ-0158	13.0	2000
JGZ-0159	14.0	2000

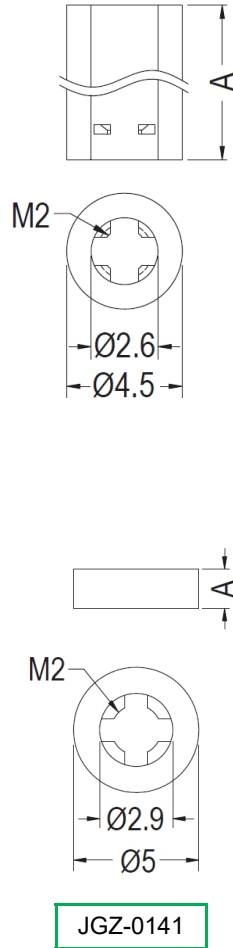

PART NO	A	PACKAGE
JGZ-0160	15.0	2000
JGZ-0161	15.9	2000
JGZ-0162	16.0	2000
JGZ-0163	17.0	1000
JGZ-0164	18.0	1000
JGZ-0165	19.0	1000
JGZ-0166	20.0	1000
JGZ-0167	21.0	1000
JGZ-0168	22.0	1000
JGZ-0169	23.0	1000
JGZ-0170	24.0	1000
JGZ-0171	25.0	1000
JGZ-0172	25.4	1000
JGZ-0173	26.0	1000
JGZ-0174	27.0	1000
JGZ-0175	28.0	1000
JGZ-0176	29.0	1000
JGZ-0177	30.0	1000

# 隔离柱 SPACER SUPPORT 间隔柱 电路板隔离柱

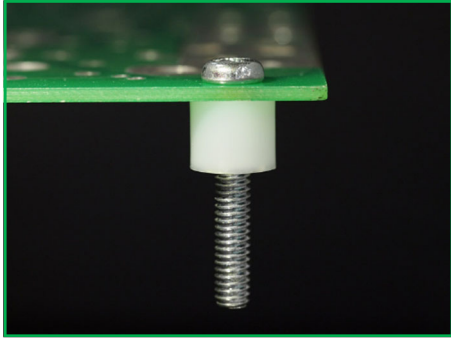

- ◆ MATERIAL : NYLON 66 (UL)
- ◆ FLAME CLASS : 94V-0/94V-2
- ◆ COLOR : TRANSPARENT/BLACK
- ◆ UNIT: mm

用途： 隔离柱,也称电路板隔离柱，作为电路板与电路板或机板间之固定不掉落。

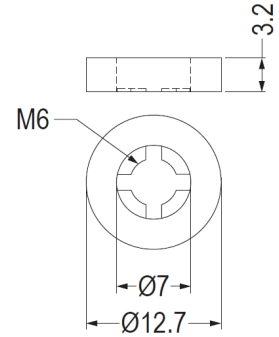
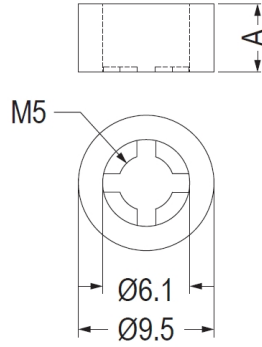

PART NO	A	PACKAGE
JGZ-0183	3.2	2000
JGZ-0184	4.8	2000
JGZ-0185	7.9	1000
JGZ-0187	6.4	2000

PART NO	PACKAGE
JGZ-0186	1000



## 隔离柱 SPACER 间隔柱 电路板隔离柱



- ◆ MATERIAL : ABS (UL)
- ◆ FLAME CLASS : 94HB
- ◆ COLOR : NATURAL
- ◆ UNIT: mm

用途： 隔离柱,也称电路板隔离柱， 做为电路板与机板间固定用，需配合M3螺丝用。

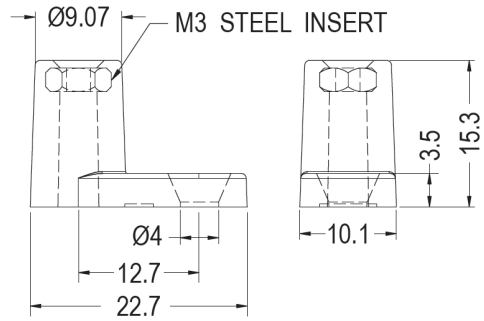

PART NO	PACKAGE
JGZ-0102	1000

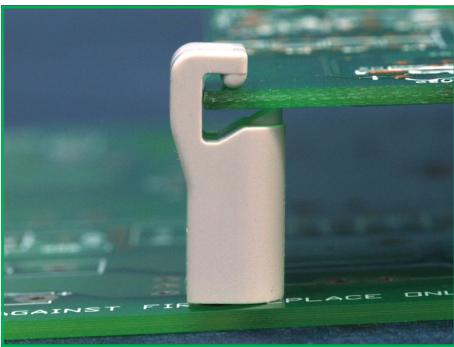

- ◆ MATERIAL : NYLON 66(UL)
- ◆ FLAME CLASS : 94V-0/94V-2
- ◆ COLOR : GRAY/NATURAL
- ◆ UNIT: mm

用途： 隔离柱,也称电路板隔离柱， 用于PCB固定及垫高， 拆装方便。

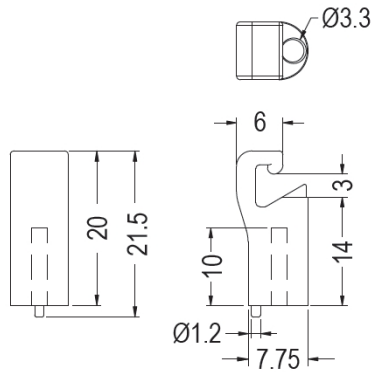

PART NO	PACKAGE
JGZ-0101	1000

# 导电隔离柱 SPACER SUPPORT 间隔柱 电路板隔离柱

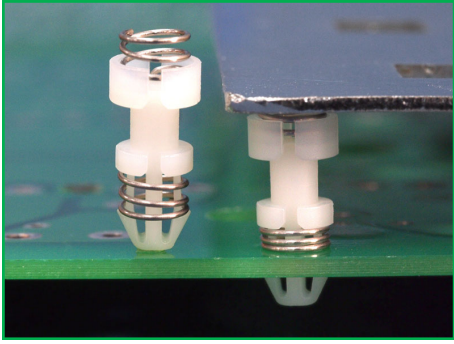

- ◆ MATERIAL : NYLON 66 (UL)
- ◆ FLAME CLASS : 94V-0/94V-2
- ◆ COLOR : NATURAL/BLACK
- ◆ UNIT: mm

用途：导电隔离柱,也称电路板隔离柱，支撑电路板与机板间之导电。

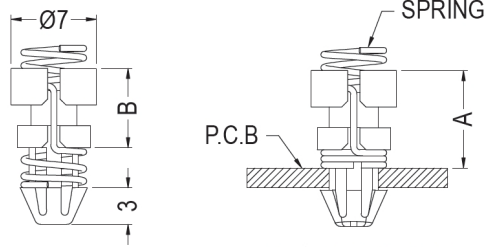

P.C.B Ø4.0  
THICKNESS 0.8~1.6

彈簧壓縮後視圖

PART NO	A	B	PACKAGE
ROFFK-2	8.0	6.5	1000
ROFFK-3	9.0	7.5	1000
ROFFK-4	10.0	8.5	1000
ROFFK-5	12.0	10.5	1000
ROFFK-6	14.0	12.5	1000
ROFFK-7	16.0	14.5	1000

# 电子电脑塑胶五金零件目录

1.LED间隔柱

2.LED导光柱 LED导光盖 LED遮光罩

3.LED座 LED座套 红外线灯罩 光纤座

4.90°LED灯座 45°LED灯座

5. PC板间隔柱 PC板隔离柱

6. 塑料铜柱 尼龙柱 六角隔离柱 塑胶铜柱 铜柱 导光板隔离柱 圆体间隔柱 PC板固定定座 固定扣 电路板隔离柱 导电隔离柱

7. 排线固定座 自粘式配线固定座 排线固定夹 压线板 电线固定座 扭线固定座 扭式固定环 扎线固定座 电源线固定座 电源线固定座插头固定扣 天线固定座 T8灯管固定座 风扇束线座 光纤固定座

8. PC板端子 接线插片端子 PC板焊接端子 接地片 圆形连接片 弹片 测试针 探针 测试点 保险丝座 保险丝盖 插式电线连接头 闭端端子 弹簧螺纹端子 压线帽 端子台 快速接线夹 跳线

9. 仪表脚垫 插销式脚垫 螺丝固定脚垫 脚垫 抗震脚垫 磁铁脚垫 橡胶脚垫 自粘脚垫 银框脚垫 金框脚垫 橡胶垫圈 橡胶华司 橡胶垫片 硅胶脚垫

10. 塑料螺丝 塑胶螺丝 翼型塑料螺丝 塑料螺帽 塑料螺帽 蝶形螺母 止付螺丝 紧定螺钉 内牙螺丝 螺丝帽盖 手转螺丝 手拧螺丝 滚花螺丝 手转螺母 手拧螺母

11. PC板拉柄 PC板耳把 PC板导槽 电路板导轨 PCB导轨槽 直立式导槽 电路板导轨

12. 晶体管盖 电晶体盖 晶体管垫片 电晶体垫片 晶体管座 电晶体座 T-O3晶体管座 石英晶体垫片 垫圈 华司 垫片 TO-220晶体管座 光电晶体座 电晶体座 IR晶体座 霍尔晶体座 硅胶帽套 功率晶体导热硅片 功率晶体压板 电源固定压条 晶体管固定弹片 五金弹片 电晶体固定弹片 晶体管夹

# 电子电脑塑胶五金零件目录

13.电容器垫片 垫圈 华司 电容器座 电容器帽套 电容器固定座 电容器盖 电容器护套 压敏护套 硅胶帽套

14.热敏电阻座 电阻保护座 保护电阻器 可变电阻盖

15.陶瓷零件垫片 零件垫片 垫圈 华司 零件垫座 IC座 桥式整流座 跳线座 线圈座 滤波器垫片 绝缘柱 螺丝垫片 滚轮 PC板垫片 球击缓冲垫片 尼龙垫圈 尼龙弹簧垫片 散热陶瓷垫片

16.功率IC盖 桥式整流盖 保护盖 开关盖 硅胶盖 绝缘盖 电池盖 末端套管 软质端子保护套PC端子保护套 喇叭座 拉柄箱扣 线圈固定座 DRAM固定带 十字型插件式固定器 轨道固定器

17.孔塞 扣式孔塞 扣式塞头 DVI防尘盖 螺丝孔孔塞 螺丝塞头 螺纹孔塞

18.电源线扣 电线固定夹 护线环 橡胶圈 护线圈 开口式护线环 橡胶线环 硅胶线环 硅胶护线环 天线护线环 方型护线环 U型护线环 抗震护线环 防震线环 抗震线环用插销 抗震线环用螺丝 硬盘驱动器防震座 透气压力平衡固定头 透气平衡压力固定扣

19.把手 机箱把手 仪器门拉手 纸箱把手 纸箱配件 打包扣 外箱护脚垫 纸箱外箱扣

20.阻尼齿轮 阻尼器 缓冲齿轮

21.电线扎带 电线束线带 固定带 扎线 电源线收线带 珠型扎带 水管座 扎带座 扎带扣 吊勾粘扣带 绑线带

22.USB座护盖 USB端口保护盖 USB端口防尘盖 MICRO USB防尘盖 MINI USB座护盖USB Type-C防尘盖 USB防尘盖 RJ-45防尘盖 RJ-11防尘盖 RJ-12防尘盖 RJ-22防尘盖 电源插头防尘盖 电源插头保护座 电源插头防尘座 电源插头防尘盖 光纤连接器护盖 光纤连接器护套 光纤防尘盖 PC板金手指防尘盖 HDMI防尘盖 Mini数位端子防尘盖 汽车点烟器防尘盖BBU防尘盖 DVI防尘盖 连接器盖 SIM Card Cap防尘盖 SD防尘盖 KVM防尘盖 CF防尘盖 防尘盖 端子盖 S端子盖 平衡端子盖 BNC绝缘座 SATA防尘盖 ESATA护盖 DP端子防尘盖 Mini D.P数位端子防尘盖 D.Type防尘盖 VGA防尘盖 IDE Connector防尘盖 PC端子防尘盖 端子防尘盖 1394端子防尘盖 零件盖 电源盖 机板电源保护盖 连接器座 PCMIC卡保护盖 面板 DDR防尘盖 D-Sub保护盖 高压防尘盖 SD保护盖 Micoro SD卡保护盖 SIM卡保护盖 防水帽盖 帽盖连接带 防水圈 电脑风扇防护盖 电脑风扇防尘座 电脑风扇框护垫 电脑风扇支架 开关遮板 光纤晶体座

# 电子电脑塑胶五金零件目录

23.插销 铆钉 尼龙铆钉 螺丝铆钉 散热片铆钉 塑料铆钉 电脑风扇铆钉 散热片扣件 弹簧铆钉 螺丝固定座 膨胀螺栓 墙塞 无帽鱼型膨胀管 墙面固定座 石膏板固定座

24.固定扣 门扣开关 机器门扣开关 弹簧固定座 旋转型门扣 门扣碰珠 磁铁门扣

55.工具 线扣工具 进口束线枪 旗型端子工具 国产束线枪 非绝缘端子工具 绝缘端子工具



# 电子电脑塑胶五金零件目录



1.LED间隔柱



2.LED导光柱



3.LED座



4.90°LED灯座



5.PC板间隔柱



6.塑料铜柱



7.排线固定座



8.PC板端子



9.仪表脚垫



10.塑料螺丝



11.PC板拉柄导槽



12.晶体管盖



13.电容器垫片



14.热敏电阻座



15.陶瓷零件垫片



16.功率IC盖



# 电子电脑塑胶五金零件目录



17.孔塞



18.电源线扣



19.机箱把手



20.阻尼齿轮



21.电线扎带



22.USB座护盖



23.尼龙铆钉



24.门扣开关



55.工具

## 电子电脑塑胶五金零件

PLASTIC HARDWARE & ELECTRONIC COMPONENTS



南京诺金电气有限公司  
Nanjing Nojinqing Electric Co., Ltd.

2023.03/17th

选型手册总目录

本公司保留因质量改进、后续开发或生产要求引起的设计更改权力。本产品目录为元件的详细说明，不能做担保依据。使用者有义务审核该元件是否符合应用范围的规定。



微信



QQ

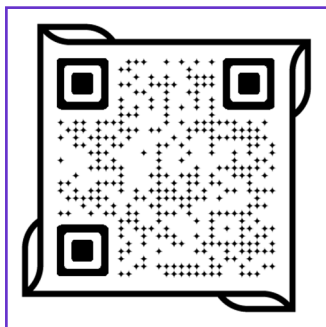

网站

## 南京诺金电气有限公司

Nanjing Nowking Electric Co., Ltd

- ◆ Tel: 025-85422485 85436028 85437901
- ◆ Wechat/Mobile :13770725488
- ◆ QQ:260678075
- ◆ E-mail: nk@nowking.com
- ◆ Http://www.nowking.com
- ◆ Http://www.kyphe.com