

# 南京诺金电气有限公司

## Nanjing Nowking Electric Co., Ltd

PC 板垫片 PCB 板垫片

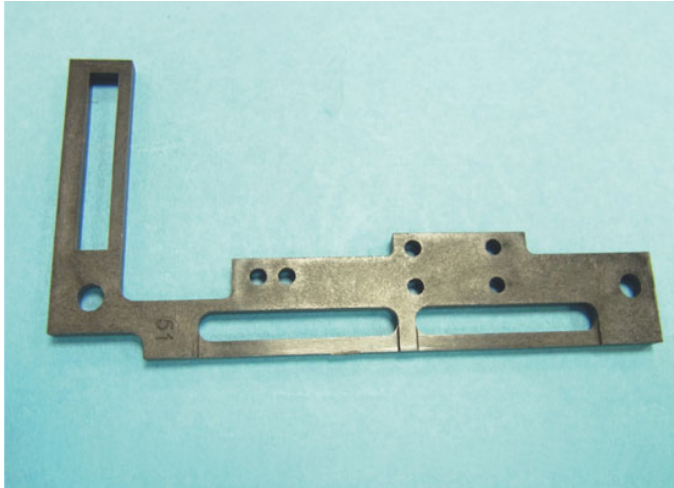

产品名称: PC 板垫片 | PCB 板垫片

规格型号: **PCM-1**

- ◆ MATERIAL: NYLON 46(UL)
- ◆ FLAME CLASS:94V-0,
- ◆ COLOR: BLACK,NATURAL
- ◆ UNIT:mm

用途: 用于零件之垫片

PCM-1 产品规格图

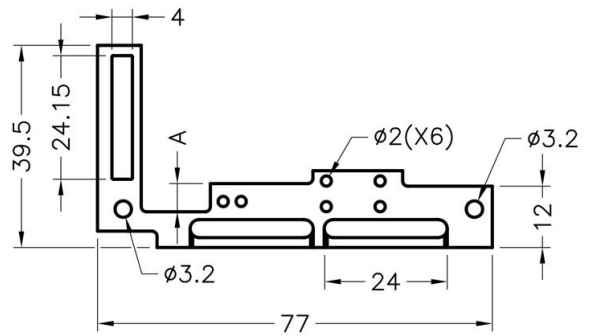

	PART NO	A	PACKAGE
	PCM-1	5.0	500

# 南京诺金电气有限公司

## Nanjing Nowking Electric Co., Ltd

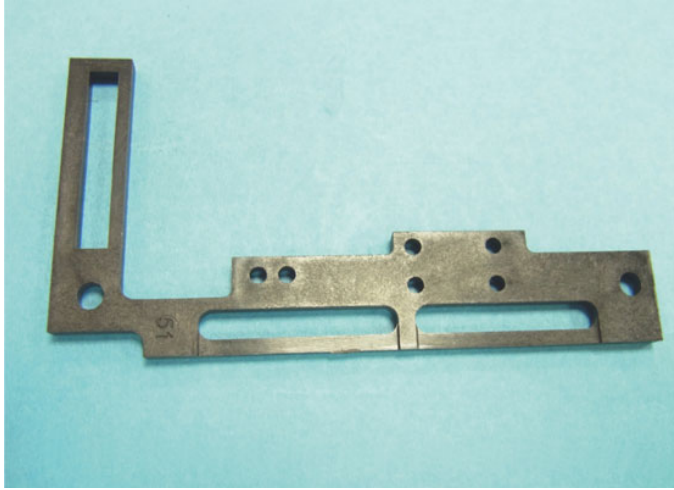

产品名称: PC板垫片|PCB板垫片

规格型号: **PCM-2**

◆ MATERIAL: NYLON 46(UL)

◆ FLAME CLASS:94V-0,

◆ COLOR: BLACK,NATURAL

◆ UNIT:mm

用途: 用于零件之垫片

PCM-2 产品规格图

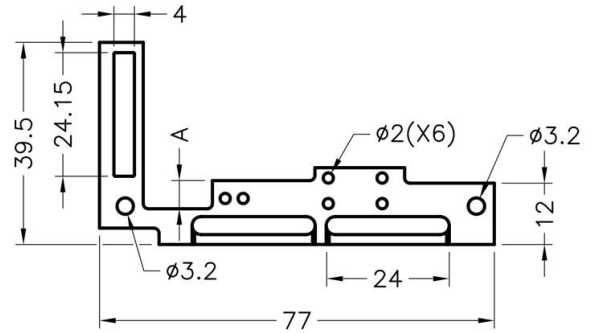
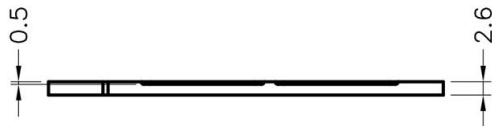

	PART NO	A	PACKAGE
	PCM-2	5.5	500

# 南京诺金电气有限公司

## Nanjing Nowking Electric Co., Ltd

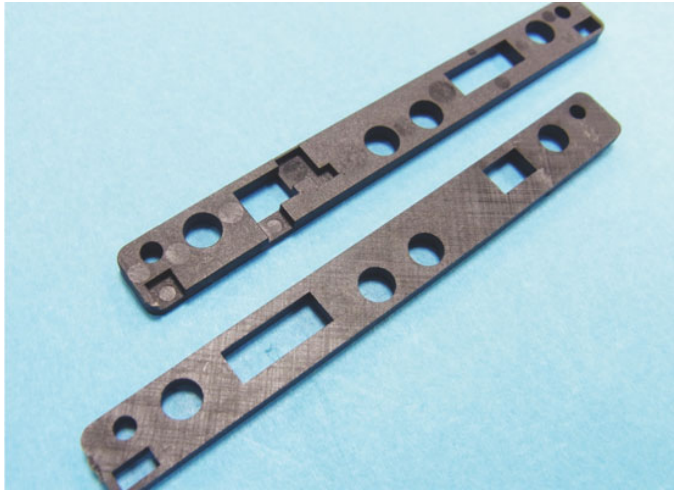

产品名称: PC 板垫片 | PCB 板垫片

规格型号: **PCM-3**

- ◆ MATERIAL: NYLON 6T(UL)
- ◆ FLAME CLASS: 94V-0,
- ◆ COLOR: BLACK, NATURAL
- ◆ UNIT: mm

用途: 用于零件之垫片

PCM-3 产品规格图

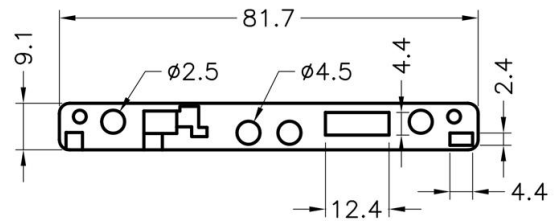
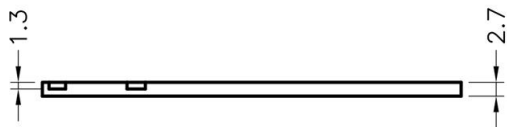

	PART NO	PACKAGE
	PCM-3	500

# 南京诺金电气有限公司

## Nanjing Nowking Electric Co., Ltd

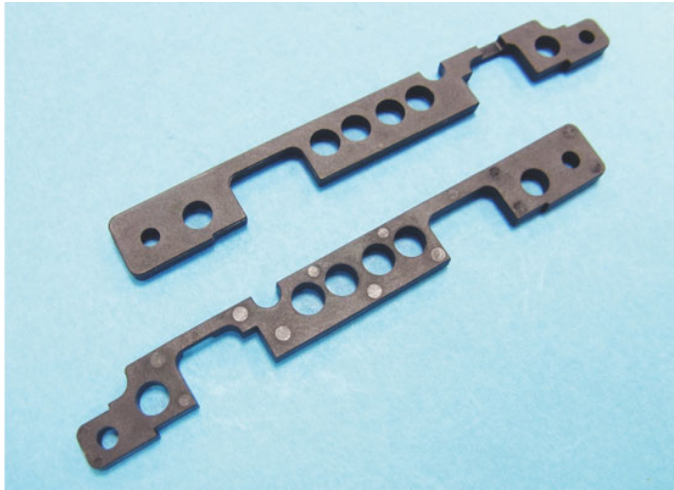

产品名称: PC 板垫片 | PCB 板垫片

规格型号: **PCM-4**

◆ MATERIAL: NYLON 6T(UL)

◆ FLAME CLASS: 94V-0,

◆ COLOR: BLACK, NATURAL

◆ UNIT: mm

用途: 用于零件之垫片

PCM-4 产品规格图

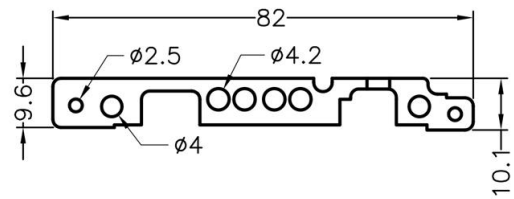
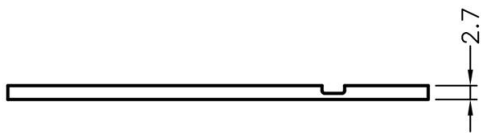

	PART NO	PACKAGE
	PCM-4	500

# 南京诺金电气有限公司

## Nanjing Nowking Electric Co., Ltd



产品名称: PC 板垫片 | PCB 板垫片

规格型号: **PCM-5**

◆ MATERIAL: NYLON 46(UL)

◆ FLAME CLASS:94V-0

◆ COLOR: BLACK,NATURAL

◆ UNIT:mm

用途: 用于零件之垫片

PCM-5 产品规格图

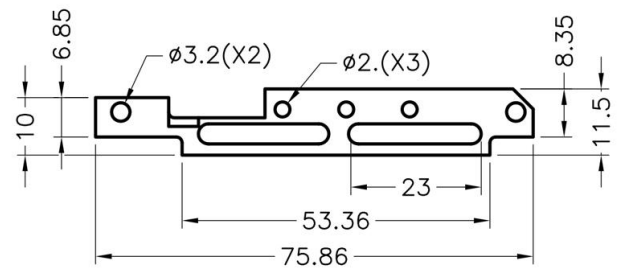
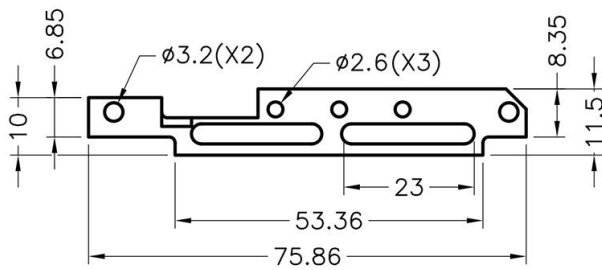

	PART NO	PACKAGE
	PCM-5	500

# 南京诺金电气有限公司

## Nanjing Nowking Electric Co., Ltd

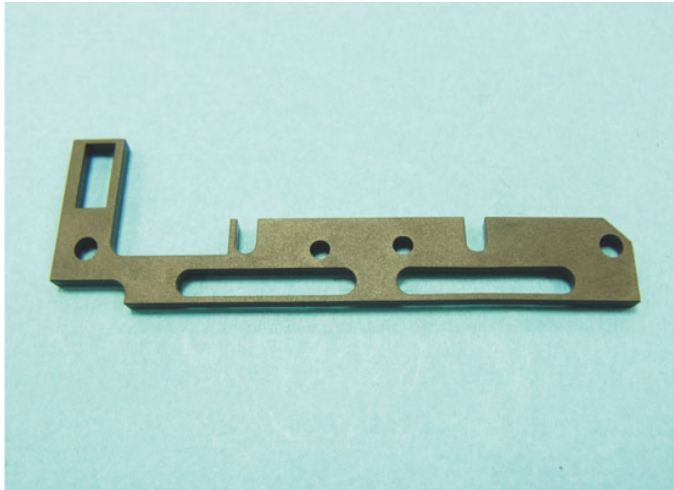

产品名称: PC 板垫片 | PCB 板垫片

规格型号: **PCM-6**

◆ MATERIAL: NYLON 46(UL)

◆ FLAME CLASS:94V-0

◆ COLOR: BLACK,NATURAL

◆ UNIT:mm

用途: 用于零件之垫片

PCM-6 产品规格图

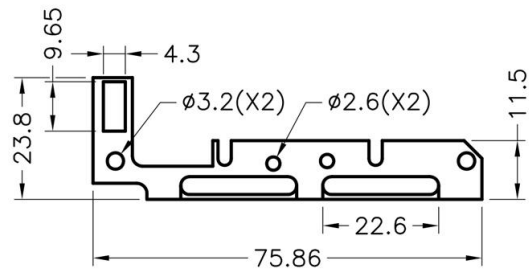

	PART NO	PACKAGE
	PCM-6	200

# 南京诺金电气有限公司

## Nanjing Nowking Electric Co., Ltd

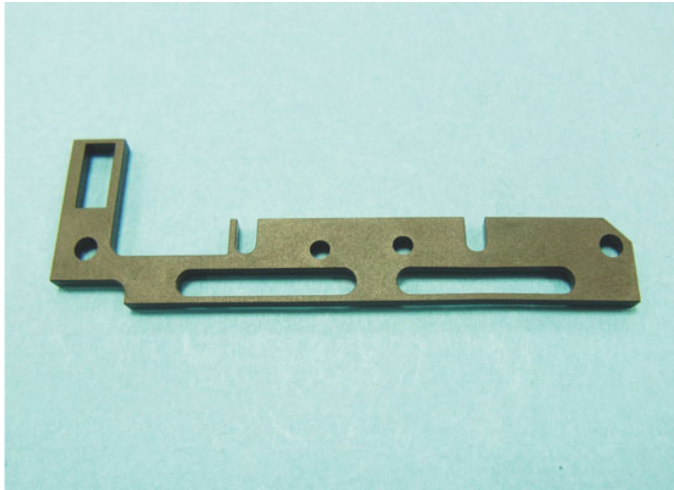

产品名称: PC 板垫片 | PCB 板垫片

规格型号: **PCM-7**

- ◆ MATERIAL: NYLON 46(UL)
- ◆ FLAME CLASS: 94V-0
- ◆ COLOR: BLACK, NATURAL
- ◆ UNIT: mm

用途: 用于零件之垫片

PCM-7 产品规格图

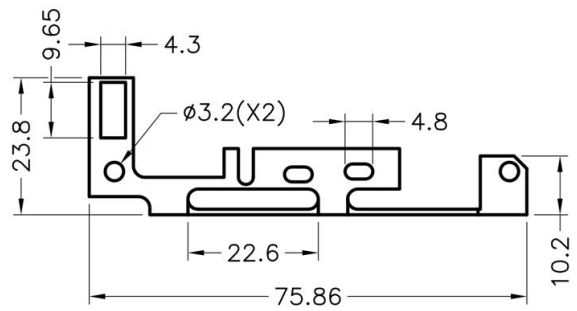
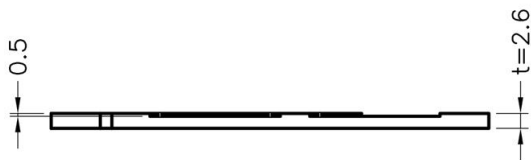

	PART NO	PACKAGE
	PCM-7	200

# 南京诺金电气有限公司

## Nanjing Nowking Electric Co., Ltd

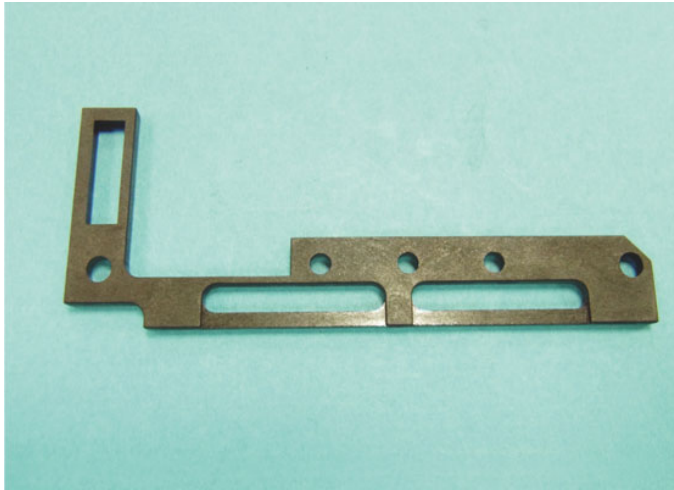

产品名称: PC 板垫片 | PCB 板垫片

规格型号: **PCM-8**

◆ MATERIAL: NYLON 46(UL)

◆ FLAME CLASS: 94V-0

◆ COLOR: BLACK, NATURAL

◆ UNIT: mm

用途: 用于零件之垫片

PCM-8 产品规格图

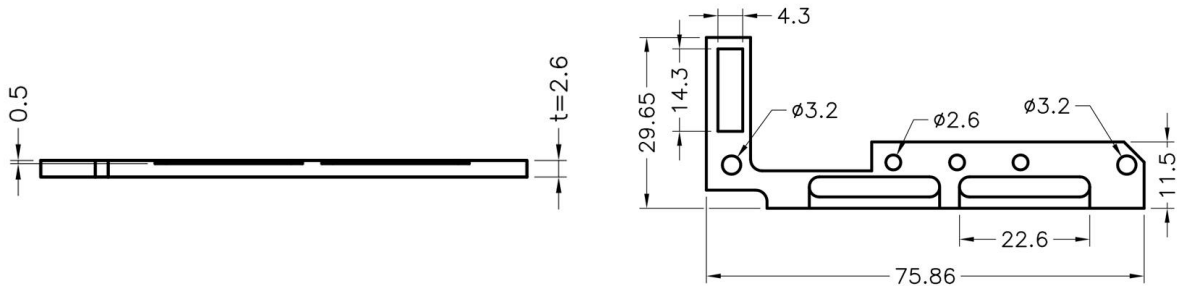

	PART NO	PACKAGE
	PCM-8	200



# 南京诺金电气有限公司

## Nanjing Nowking Electric Co., Ltd

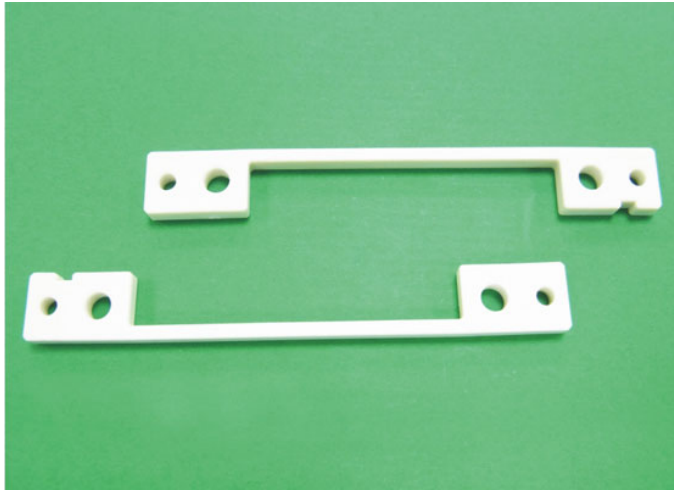

产品名称: PC 板垫片 | PCB 板垫片

规格型号: **PCM-9**

- ◆ MATERIAL: NYLON 6T(UL)
- ◆ FLAME CLASS: 94V-0
- ◆ COLOR: BLACK, NATURAL, WHITE
- ◆ UNIT: mm

用途: 用于零件之垫片

PCM-9 产品规格图

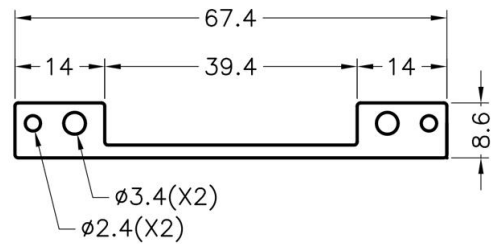
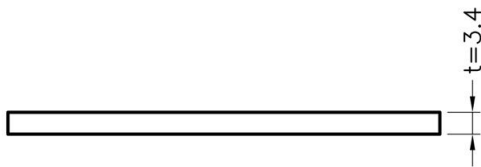

	PART NO	PACKAGE
	PCM-9	500

# 南京诺金电气有限公司

## Nanjing Nowking Electric Co., Ltd

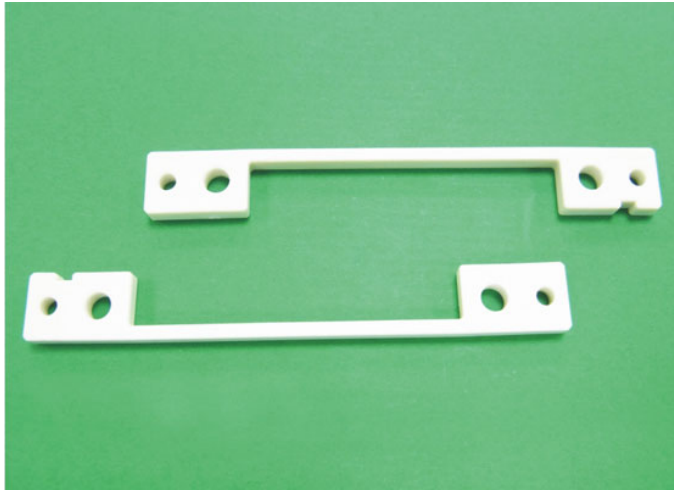

产品名称: PC 板垫片 | PCB 板垫片

规格型号: **PCM-10**

- ◆ MATERIAL: NYLON 6T(UL)
- ◆ FLAME CLASS: 94V-0
- ◆ COLOR: BLACK, NATURAL, WHITE
- ◆ UNIT: mm

用途: 用于零件之垫片

PCM-10 产品规格图

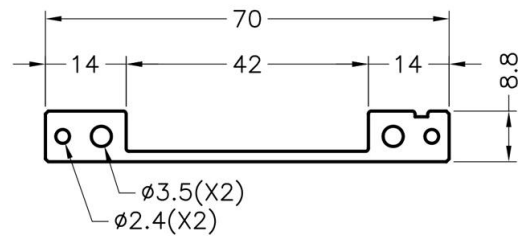
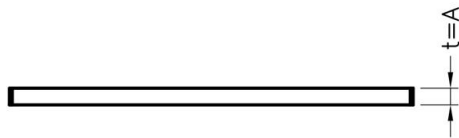

	PART NO	A	PACKAGE
	PCM-10	2.9	500

# 南京诺金电气有限公司

## Nanjing Nowking Electric Co., Ltd

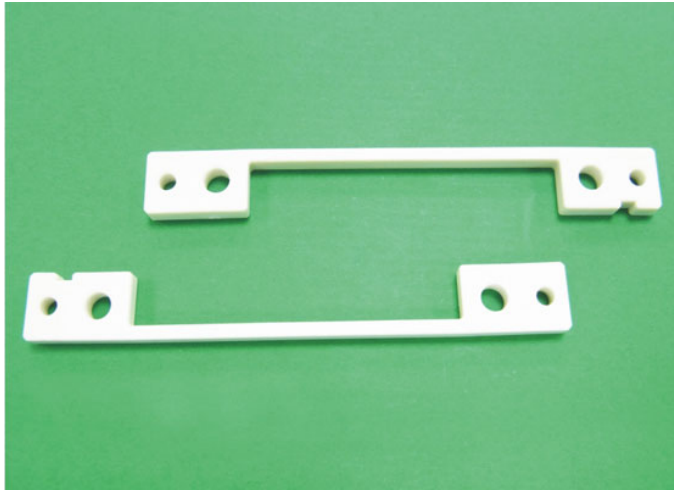

产品名称: PC板垫片|PCB板垫片

规格型号: **PCM-11**

- ◆ MATERIAL: NYLON 6T(UL)
- ◆ FLAME CLASS: 94V-0
- ◆ COLOR: BLACK, NATURAL, WHITE
- ◆ UNIT: mm

用途: 用于零件之垫片

PCM-11 产品规格图

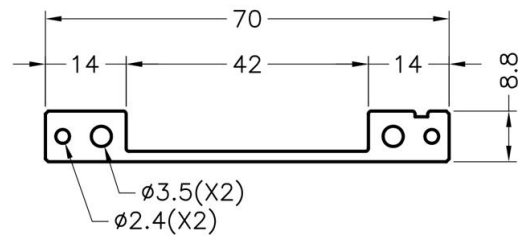
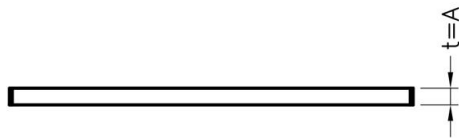

	PART NO	A	PACKAGE
	PCM-11	3.4	500

# 南京诺金电气有限公司

## Nanjing Nowking Electric Co., Ltd

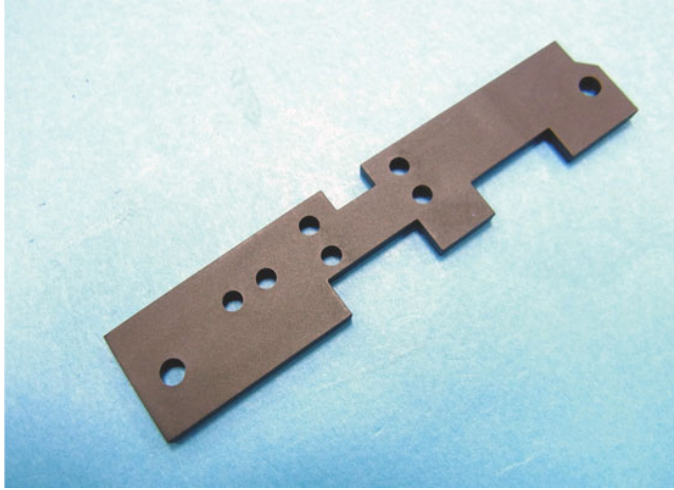

产品名称: PC 板垫片 | PCB 板垫片

规格型号: **PCM-12**

◆ MATERIAL: NYLON 46(UL)

◆ FLAME CLASS: 94V-0

◆ COLOR: BLACK

◆ UNIT: mm

用途: 用于零件之垫片

PCM-12 产品规格图

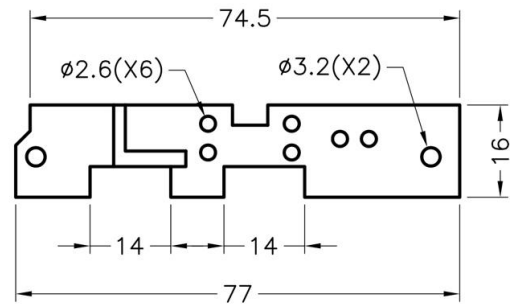
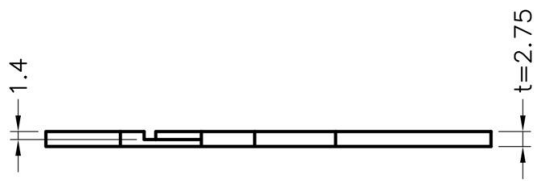

	PART NO	PACKAGE
	PCM-12	500